

I D E A L
F O R M
T E A M
DIVISIONE UFFICI



ELECTA
designed by Nikolas Chachamis

OTTOBRE 2004

OCTOBER 2004

S R L
VIA PIEMONTE 14
60030 MONSANO
(A N) I T A L Y
TEL. (+39) 0731/605531
FAX (+39) 0731/60010
<http://www.idealformteam.com>
E-mail: ift@idealformteam.com

INDICE
INDEX

Sostegni	2
<i>Supports</i>	
Piani per scrivanie e tavoli riunione	3
<i>Desks and meeting tables surfaces</i>	
Scrivanie con fianchi	12
<i>Desks with quad legs</i>	
Tavoli riunione con fianchi	18
<i>Meeting tables with quad legs</i>	
Scrivanie con gambe	19
<i>Desks with legs</i>	
Tavoli riunione con gambe	25
<i>Meeting tables with legs</i>	
Gonne	28
<i>Modesty panels</i>	
Cassettiere e portacomputers	29
<i>Pedestals and computer holders</i>	
Contenitori di servizio h. 63,7	30
<i>Storage units h. 63,7</i>	
Componenti contenitori di servizio	34
<i>Storage units components</i>	
Contenitori h. 82,2	35
<i>Storage units h. 82,2</i>	
Componenti per contenitori h. 82,2	44
<i>Components for h. 82,2 storage units</i>	
Contenitori h. 159	45
<i>Storage units h. 159</i>	
Componenti per contenitori h. 159	56
<i>Components for h. 159 storage units</i>	
Contenitori h. 197,5	58
<i>Storage units h. 197,5</i>	
Componenti per contenitori h. 197,5	69
<i>Components for h. 197,5 storage units</i>	
Librerie	71
<i>Bookcases</i>	
Componenti per contenitori prof. 46,5	72
<i>Components for 46,5 depth storage units</i>	
Serrature	78
<i>Locks</i>	

MODIFICHE PRODUTTIVE

La ditta si riserva di apportare modifiche dimensionali o strutturali ai suoi prodotti in qualsiasi momento e senza alcun preavviso.

PRODUCTION MODIFICATIONS

The company reserves the right to modify the structure or dimensions of its products without notice at any time.

SOSTEGNI PER SCRIVANIE, ALLUNGI E TAVOLI RIUNIONE IN ROVERE/ALLUMINIO • SUPPORTS FOR DESKS, PROLONGATIONS AND MEETING TABLES IN OAK AND ALUMINIUM

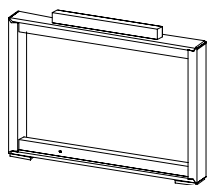

Fianco per scrivanie e tavoli riunione
Quad leg for desks and meeting tables

10	0,091	9,5	89,5	68	9VAH01.0008.71	rovere sbiancato/ <i>white oak</i>
10	0,091	9,5	89,5	68	9VAH01.0008.72	rovere moka/ <i>mocha oak</i>

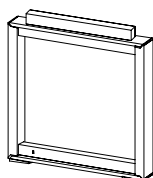

Fianco per allunghi
Quad leg for prolongations

8,5	0,067	9,5	64,5	68	9VAH02.0008.71	rovere sbiancato/ <i>white oak</i>
8,5	0,067	9,5	64,5	68	9VAH02.0008.72	rovere moka/ <i>mocha oak</i>



Gamba per scrivanie, allunghi e tavoli riunione
Leg for desks, prolongations and meeting tables

3,5	0,012	9,5	9,5	68	9VAH03.0008.71	rovere sbiancato/ <i>white oak</i>
3,5	0,012	9,5	9,5	68	9VAH03.0008.72	rovere moka/ <i>mocha oak</i>



Raccordo in alluminio per cassettiere e contenitori di servizio portanti da applicare sulle scrivanie con gambe
Aluminium connection for pedestals and supporting storage units for desks with legs

-	-	4,7	4,7	4,7	9VAH70.0008	alluminio/ <i>aluminium</i>
---	---	-----	-----	-----	--------------------	-----------------------------

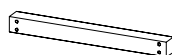

Raccordo in alluminio per cassettiere e contenitori di servizio portanti da applicare sulle scrivanie con fianchi
Aluminium connection for pedestals and supporting storage units for desks with quad legs

0,8	0,002	50	4,5	4,7	9VAH60.0008	alluminio/ <i>aluminium</i>
-----	-------	----	-----	-----	--------------------	-----------------------------

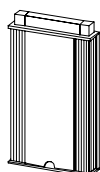

Gamba per tavoli riunione componibili
Leg for modular meeting tables

10,5	0,048	9,5	39	68	9VAH04.0008.71	rovere sbiancato/ <i>white oak</i>
10,5	0,048	9,5	39	68	9VAH04.0008.72	rovere moka/ <i>mocha oak</i>

PIANI IN ROVERE P. 90 PER SCRIVANIE CON FIANCHI • OAK TOPS 90 D. FOR DESKS WITH QUAD LEGS

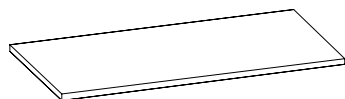

Piano in rovere per scrivania con fianchi
Oak top for desk with quad legs

42	0,17	180	90	4	9VAJ01.4501.71	rovere sbiancato/white oak
42	0,17	180	90	4	9VAJ01.4501.72	rovere moka/mocka oak

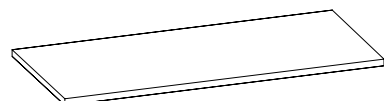

Piano in rovere per scrivania con fianchi
Oak top for desk with quad legs

47	0,188	200	90	4	9VAJ02.4501.71	rovere sbiancato/white oak
47	0,188	200	90	4	9VAJ02.4501.72	rovere moka/mocka oak

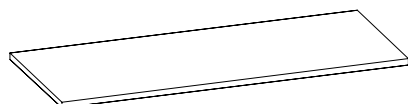

Piano in rovere per scrivania con fianchi
Oak top for desk with quad legs

51,5	0,206	220	90	4	9VAJ03.4501.71	rovere sbiancato/white oak
51,5	0,206	220	90	4	9VAJ03.4501.72	rovere moka/mocka oak

PIANI IN ROVERE P. 65 PER SCRIVANIE CON FIANCHI • OAK TOPS 65 D. FOR DESKS WITH QUAD LEGS

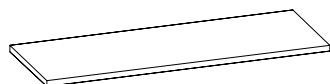

Piano in rovere per scrivania con fianchi
Oak top for desk with quad legs

30,5	0,126	180	65	4	9VAJ11.4501.71	rovere sbiancato/white oak
30,5	0,126	180	65	4	9VAJ11.4501.72	rovere moka/mocka oak

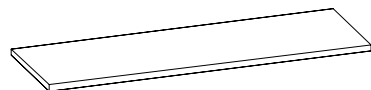

Piano in rovere per scrivania con fianchi
Oak top for desk with quad legs

34	0,139	200	65	4	9VAJ12.4501.71	rovere sbiancato/white oak
34	0,139	200	65	4	9VAJ12.4501.72	rovere moka/mocka oak

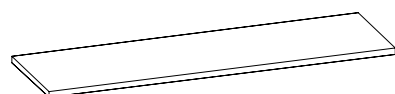

Piano in rovere per scrivania con fianchi
Oak top for desk with quad legs

37,5	0,153	220	65	4	9VAJ13.4501.71	rovere sbiancato/white oak
37,5	0,153	220	65	4	9VAJ13.4501.72	rovere moka/mocka oak

PIANI IN CRISTALLO P. 90 PER SCRIVANIE CON FIANCHI • GLASS TOPS 90 D. FOR DESKS WITH QUAD LEGS

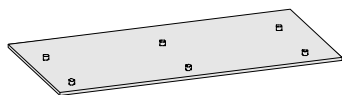

Piano in cristallo satinato temperato per scrivania con fianchi
Tempered frosted glass top for desk with quad legs

105,5	0,234	180	90	1,5	9VAJ81.0030	cristallo satinato/ <i>frosted glass</i>
-------	-------	-----	----	-----	--------------------	--

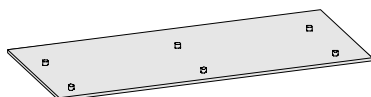

Piano in cristallo satinato temperato per scrivania con fianchi
Tempered frosted glass top for desk with quad legs

117,5	0,259	200	90	1,5	9VAJ82.0030	cristallo satinato/ <i>frosted glass</i>
-------	-------	-----	----	-----	--------------------	--

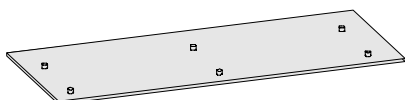

Piano in cristallo satinato temperato per scrivania con fianchi
Tempered frosted glass top for desk with quad legs

129,5	0,284	220	90	1,5	9VAJ83.0030	cristallo satinato/ <i>frosted glass</i>
-------	-------	-----	----	-----	--------------------	--

PIANI IN CRISTALLO P. 65 PER SCRIVANIE CON FIANCHI • GLASS TOPS 65 D. FOR DESKS WITH QUAD LEGS

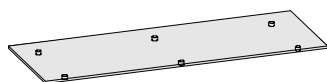

Piano in cristallo satinato temperato per scrivania con fianchi
Tempered frosted glass top for desk with quad legs

76	0,175	180	65	1,5	9VAJ91.0030	cristallo satinato/ <i>frosted glass</i>
----	-------	-----	----	-----	--------------------	--

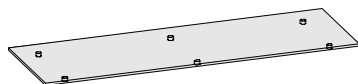

Piano in cristallo satinato temperato per scrivania con fianchi
Tempered frosted glass top for desk with quad legs

84,5	0,194	200	65	1,5	9VAJ92.0030	cristallo satinato/ <i>frosted glass</i>
------	-------	-----	----	-----	--------------------	--

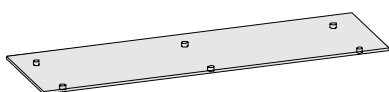

Piano in cristallo satinato temperato per scrivania con fianchi
Tempered frosted glass top for desk with quad legs

93	0,212	220	65	1,5	9VAJ93.0030	cristallo satinato/ <i>frosted glass</i>
----	-------	-----	----	-----	--------------------	--

PIANI IN ROVERE PER ALLUNGI SCRIVANIE CON FIANCHI • OAK TOPS FOR PROLONGATIONS WITH QUAD LEGS

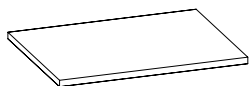

Piano in rovere per allungo scrivanie con fianchi
Oak top for prolongation with quad legs

20,5	0,085	120	65	4	9VAJ14.4501.71	rovere sbiancato/ <i>white oak</i>
20,5	0,085	120	65	4	9VAJ14.4501.72	rovere moka/ <i>mocha oak</i>



Piano in rovere per allungo scrivanie con fianchi
Oak top for prolongation with quad legs

24	0,099	140	65	4	9VAJ15.4501.71	rovere sbiancato/ <i>white oak</i>
24	0,099	140	65	4	9VAJ15.4501.72	rovere moka/ <i>mocha oak</i>

PIANI IN CRISTALLO PER ALLUNGI SCRIVANIE CON FIANCHI • GLASS TOPS FOR PROLONGATIONS WITH QUAD LEGS

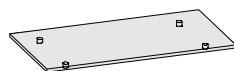

Piano in cristallo satinato temperato per allungo scrivanie con fianchi
Tempered frosted glass top for prolongation with quad legs

51	0,120	120	65	1,5	9VAJ95.0030	cristallo satinato/ <i>frosted glass</i>
----	-------	-----	----	-----	--------------------	--

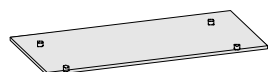

Piano in cristallo satinato temperato per allungo scrivanie con fianchi
Tempered frosted glass top for prolongation with quad legs

59,5	0,138	140	65	1,5	9VAJ96.0030	cristallo satinato/ <i>frosted glass</i>
------	-------	-----	----	-----	--------------------	--

PIANI IN ROVERE PER TAVOLI RIUNIONI CON FIANCHI • OAK TOPS FOR MEETING TABLES WITH QUAD LEGS

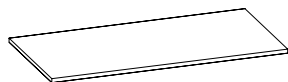

Piano in rovere per tavolo riunione con fianchi
Oak top for meeting table with quad legs

75	0,295	240	120	4	9VAJ73.4501.71	rovere sbiancato/white oak
75	0,295	240	120	4	9VAJ73.4501.72	rovere moka/mocha oak

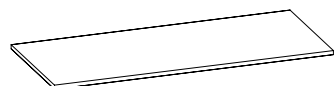

Piano in rovere per tavolo riunione con fianchi
Oak top for meeting table with quad legs

87,5	0,350	280	120	4	9VAJ74.4501.71	rovere sbiancato/white oak
87,5	0,350	280	120	4	9VAJ74.4501.72	rovere moka/mocha oak

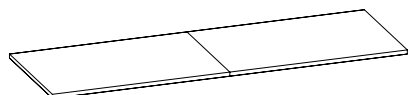

Piano in rovere per tavolo riunione con fianchi
Oak top for meeting table with quad legs

112,5	0,446	360	120	4	9VAJ75.4501.71	rovere sbiancato/white oak
112,5	0,446	360	120	4	9VAJ75.4501.72	rovere moka/mocha oak

PIANI IN ROVERE P. 90 PER SCRIVANIE CON GAMBE • OAK TOPS 90 D. FOR DESKS WITH LEGS

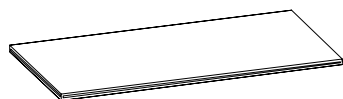

Piano in rovere con profilo in alluminio per scrivanie con gambe
Oak top with aluminium profile for desk with legs

42	0,170	180	90	4	9VAK01.4501.71	rovere sbiancato/ <i>white oak</i>
42	0,170	180	90	4	9VAK01.4501.72	rovere moka/ <i>mocha oak</i>



Piano in rovere con profilo in alluminio per scrivanie con gambe
Oak top with aluminium profile for desk with legs

47	0,188	200	90	4	9VAK02.4501.71	rovere sbiancato/ <i>white oak</i>
47	0,188	200	90	4	9VAK02.4501.72	rovere moka/ <i>mocha oak</i>



Piano in rovere con profilo in alluminio per scrivanie con gambe
Oak top with aluminium profile for desk with legs

51,5	0,206	220	90	4	9VAK03.4501.71	rovere sbiancato/ <i>white oak</i>
51,5	0,206	220	90	4	9VAK03.4501.72	rovere moka/ <i>mocha oak</i>

PIANI IN ROVERE P. 65 PER SCRIVANIE CON GAMBE • OAK TOPS 65 D. FOR DESKS WITH LEGS



Piano in rovere con profilo in alluminio per scrivanie con gambe
Oak top with aluminium profile for desk with legs

30,5	0,126	180	65	4	9VAK11.4501.71	rovere sbiancato/ <i>white oak</i>
30,5	0,126	180	65	4	9VAK11.4501.72	rovere moka/ <i>mocha oak</i>

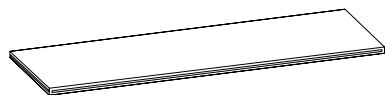

Piano in rovere con profilo in alluminio per scrivanie con gambe
Oak top with aluminium profile for desk with legs

34	0,139	200	65	4	9VAK12.4501.71	rovere sbiancato/ <i>white oak</i>
34	0,139	200	65	4	9VAK12.4501.72	rovere moka/ <i>mocha oak</i>

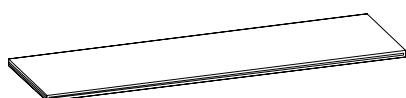

Piano in rovere con profilo in alluminio per scrivanie con gambe
Oak top with aluminium profile for desk with legs

37,5	0,153	220	65	4	9VAK13.4501.71	rovere sbiancato/ <i>white oak</i>
37,5	0,153	220	65	4	9VAK13.4501.72	rovere moka/ <i>mocha oak</i>

PIANI IN CRISTALLO P. 90 PER SCRIVANIE CON GAMBE • GLASS TOPS 90 D. FOR DESKS WITH LEGS

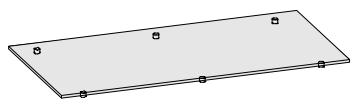

Piano in cristallo satinato temperato per scrivania con gambe
Tempered frosted glass top for desk with legs

105,5	0,234	180	90	1,5	9VAK81.0030	cristallo satinato/ <i>frosted glass</i>
-------	-------	-----	----	-----	--------------------	--

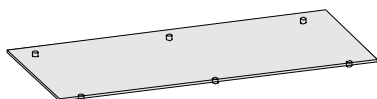

Piano in cristallo satinato temperato per scrivania con gambe
Tempered frosted glass top for desk with legs

117,5	0,259	200	90	1,5	9VAK82.0030	cristallo satinato/ <i>frosted glass</i>
-------	-------	-----	----	-----	--------------------	--

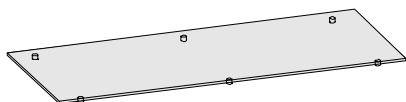

Piano in cristallo satinato temperato per scrivania con gambe
Tempered frosted glass top for desk with legs

129,5	0,284	220	90	1,5	9VAK83.0030	cristallo satinato/ <i>frosted glass</i>
-------	-------	-----	----	-----	--------------------	--

PIANI IN CRISTALLO P. 65 PER SCRIVANIE CON GAMBE • GLASS TOPS 65 D. FOR DESKS WITH LEGS

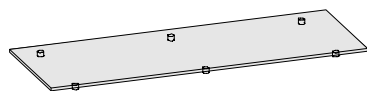

Piano in cristallo satinato temperato per scrivania con gambe
Tempered frosted glass top for desk with legs

76	0,175	180	65	1,5	9VAK91.0030	cristallo satinato/ <i>frosted glass</i>
----	-------	-----	----	-----	--------------------	--

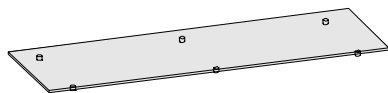

Piano in cristallo satinato temperato per scrivania con gambe
Tempered frosted glass top for desk with legs

84,5	0,194	200	65	1,5	9VAK92.0030	cristallo satinato/ <i>frosted glass</i>
------	-------	-----	----	-----	--------------------	--

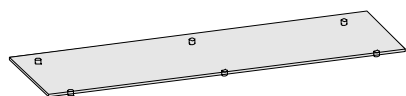

Piano in cristallo satinato temperato per scrivania con gambe
Tempered frosted glass top for desk with legs

93	0,212	220	65	1,5	9VAK93.0030	cristallo satinato/ <i>frosted glass</i>
----	-------	-----	----	-----	--------------------	--

PIANI IN ROVERE PER ALLUNGHIE SCRIVANIE CON GAMBE • OAK TOPS FOR PROLONGATIONS WITH LEGS



Piano in rovere per allungo scrivanie con gambe
Oak top for prolongation with legs

20,5	0,085	120	65	4	9VAK14.4501.71	rovere sbiancato/ <i>white oak</i>
20,5	0,085	120	65	4	9VAK14.4501.72	rovere moka/ <i>mocha oak</i>



Piano in rovere per allungo scrivanie con gambe
Oak top for prolongation with legs

24	0,099	140	65	4	9VAK15.4501.71	rovere sbiancato/ <i>white oak</i>
24	0,099	140	65	4	9VAK15.4501.72	rovere moka/ <i>mocha oak</i>

PIANI IN CRISTALLO PER ALLUNGHIE SCRIVANIE CON GAMBE • GLASS TOPS FOR PROLONGATIONS WITH LEGS

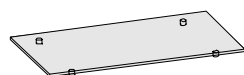

Piano in cristallo satinato temperato per allungo scrivanie con gambe
Tempered frosted glass top for prolongation with legs

51	0,120	120	65	1,5	9VAK95.0030	cristallo satinato/ <i>frosted glass</i>
----	-------	-----	----	-----	--------------------	--

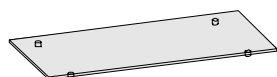

Piano in cristallo satinato temperato per allungo scrivanie con gambe
Tempered frosted glass top for prolongation with legs

59,5	0,138	140	65	1,5	9VAK96.0030	cristallo satinato/ <i>frosted glass</i>
------	-------	-----	----	-----	--------------------	--

PIANI IN ROVERE PER TAVOLI RIUNIONI CON GAMBE • OAK TOPS FOR MEETING TABLES WITH LEGS

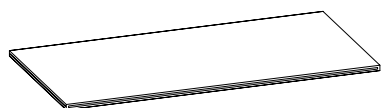

Piano in rovere per tavolo riunioni con gambe
Oak top for meeting table with legs

75	0,295	240	120	4	9VAK73.4501.71	rovere sbiancato/white oak
75	0,295	240	120	4	9VAK73.4501.72	rovere moka/mocha oak

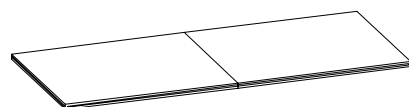

Piano in rovere per tavolo riunioni con gambe
Oak top for meeting table with legs

87,5	0,350	280	120	4	9VAK74.4501.71	rovere sbiancato/white oak
87,5	0,350	280	120	4	9VAK74.4501.72	rovere moka/mocha oak



Piano in rovere per tavolo riunioni con gambe
Oak top for meeting table with legs

51	0,203	140	140	4	9VAK71.4501.71	rovere sbiancato/white oak
51	0,203	140	140	4	9VAK71.4501.72	rovere moka/mocha oak

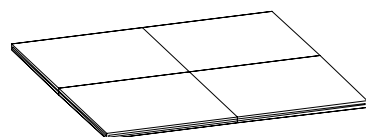

Piano in rovere per tavolo riunioni con gambe
Oak top for meeting table with legs

66,5	0,262	160	160	4	9VAK75.4501.71	rovere sbiancato/white oak
66,5	0,262	160	160	4	9VAK75.4501.72	rovere moka/mocha oak

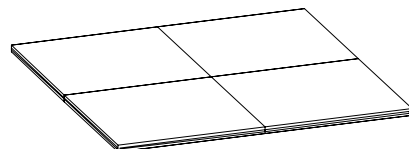

Piano in rovere per tavolo riunioni con gambe
Oak top for meeting table with legs

84,5	0,329	180	180	4	9VAK72.4501.71	rovere sbiancato/white oak
84,5	0,329	180	180	4	9VAK72.4501.72	rovere moka/mocha oak

PIANI IN CRISTALLO PER TAVOLI RIUNIONI CON GAMBE • GLASS TOPS FOR MEETING TABLES WITH LEGS

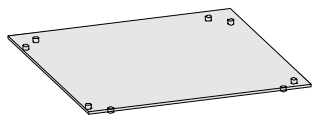

Piano in cristallo satinato temperato per tavolo riunione con gambe
Tempered frosted glass top for meeting table with legs

128,5	0,278	140	140	1,5	9VAK85.0030	cristallo satinato/ <i>frosted glass</i>
-------	-------	-----	-----	-----	--------------------	--

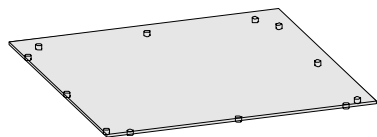

Piano in cristallo satinato temperato per tavolo riunione con gambe
Tempered frosted glass top for meeting table with legs

166,5	0,357	160	160	1,5	9VAK86.0030	cristallo satinato/ <i>frosted glass</i>
-------	-------	-----	-----	-----	--------------------	--

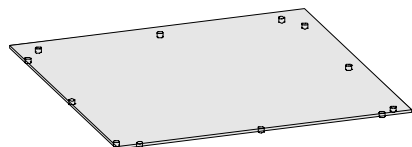

Piano in cristallo satinato temperato per tavolo riunione con gambe
Tempered frosted glass top for meeting table with legs

208,0	0,446	180	180	1,5	9VAK87.0030	cristallo satinato/ <i>frosted glass</i>
-------	-------	-----	-----	-----	--------------------	--

SCRIVANIE P. 90 IN ROVERE CON FIANCHI • OAK DESKS 90 D. WITH QUAD LEGS

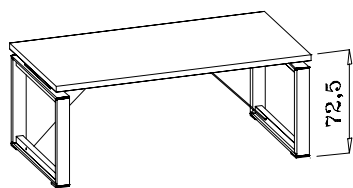

Scrivania direzionale con fianchi, piano in rovere,
travi sottopiano in alluminio
*Executive desk with quad legs, oak top,
aluminium beams*

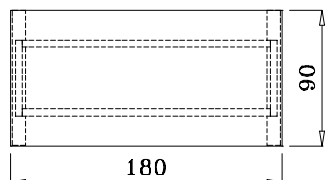

67	0,370	180	90	72,5	9VAL01.4501.71	rovere sbiancato/ <i>white oak</i>
67	0,370	180	90	72,5	9VAL01.4501.72	rovere moka/ <i>mocha oak</i>

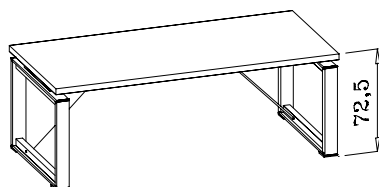

Scrivania direzionale con fianchi, piano in rovere,
travi sottopiano in alluminio
*Executive desk with quad legs, oak top,
aluminium beams*

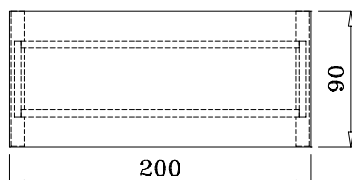

72,6	0,390	200	90	72,5	9VAL02.4501.71	rovere sbiancato/ <i>white oak</i>
72,6	0,390	200	90	72,5	9VAL02.4501.72	rovere moka/ <i>mocha oak</i>

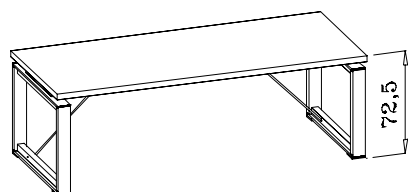

Scrivania direzionale con fianchi, piano in rovere,
travi sottopiano in alluminio
*Executive desk with quad legs, oak top,
aluminium beams*

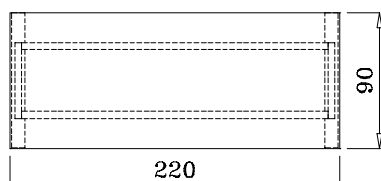

77,7	0,410	220	90	72,5	9VAL03.4501.71	rovere sbiancato/ <i>white oak</i>
77,7	0,410	220	90	72,5	9VAL03.4501.72	rovere moka/ <i>mocha oak</i>

SCRIVANIE P. 90 IN CRISTALLO CON FIANCHI • GLASS TOP DESKS 90 D. WITH QUAD LEGS

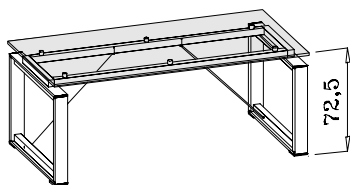

Scrivania direzionale con fianchi, piano in cristallo satinato temperato, travi sottopiano in alluminio
Executive desk with quad legs, tempered frosted glass top, aluminium beams

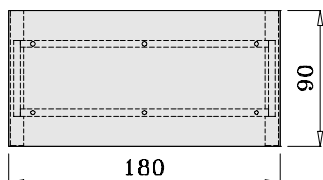

130,5	0,434	180	90	72,5	9VAL81.0030.71	rovere sbiancato/ <i>white oak</i>
130,5	0,434	180	90	72,5	9VAL81.0030.72	rovere moka/ <i>mocha oak</i>

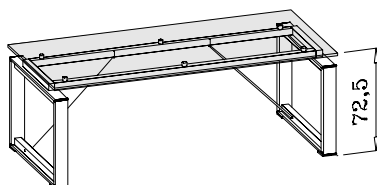

Scrivania direzionale con fianchi, piano in cristallo satinato temperato, travi sottopiano in alluminio
Executive desk with quad legs, tempered frosted glass top, aluminium beams

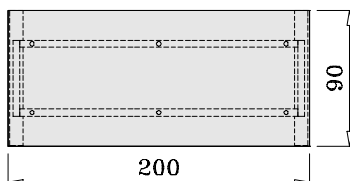

143,10	0,461	200	90	72,5	9VAL82.0030.71	rovere sbiancato/ <i>white oak</i>
143,10	0,461	200	90	72,5	9VAL82.0030.72	rovere moka/ <i>mocha oak</i>

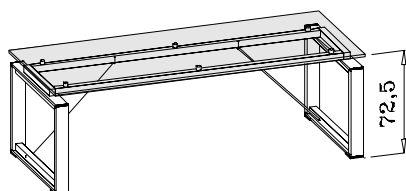

Scrivania direzionale con fianchi, piano in cristallo satinato temperato, travi sottopiano in alluminio
Executive desk with quad legs, tempered frosted glass top, aluminium beams

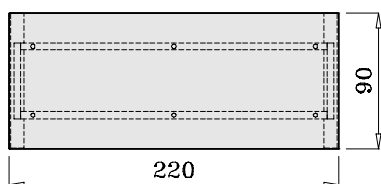

155,7	0,488	220	90	72,5	9VAL83.0030.71	rovere sbiancato/ <i>white oak</i>
155,7	0,488	220	90	72,5	9VAL83.0030.72	rovere moka/ <i>mocha oak</i>

SCRIVANIE P. 65 IN ROVERE CON FIANCHI • OAK DESKS 65 D. WITH QUAD LEGS

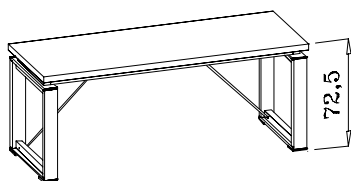

Scrivania direzionale con fianchi, piano in rovere,
travi sottopiano in alluminio
*Executive desk with quad legs, oak top,
aluminium beams*

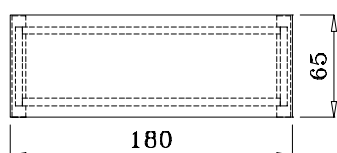

52,5	0,278	180	65	72,5	9VAL11.4501.71	rovere sbiancato/ <i>white oak</i>
52,5	0,278	180	65	72,5	9VAL11.4501.72	rovere moka/ <i>mocha oak</i>

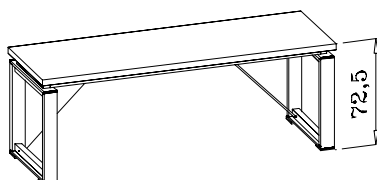

Scrivania direzionale con fianchi, piano in rovere,
travi sottopiano in alluminio
*Executive desk with quad legs, oak top,
aluminium beams*

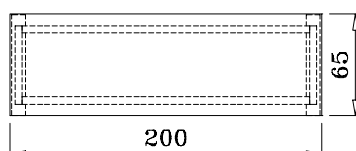

56,6	0,293	200	65	72,5	9VAL12.4501.71	rovere sbiancato/ <i>white oak</i>
56,6	0,293	200	65	72,5	9VAL12.4501.72	rovere moka/ <i>mocha oak</i>

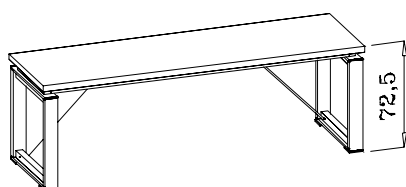

Scrivania direzionale con fianchi, piano in rovere,
travi sottopiano in alluminio
*Executive desk with quad legs, oak top,
aluminium beams*

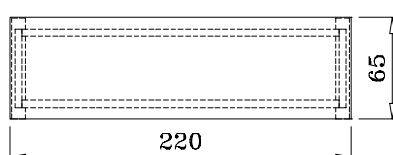

60,7	0,309	220	65	72,5	9VAL13.4501.71	rovere sbiancato/ <i>white oak</i>
60,7	0,309	220	65	72,5	9VAL13.4501.72	rovere moka/ <i>mocha oak</i>

SCRIVANIE P. 65 IN CRISTALLO CON FIANCHI • GLASS TOP DESKS 65 D. WITH QUAD LEGS

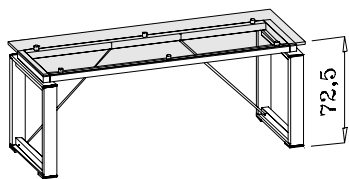

Scrivania direzionale con fianchi, piano in cristallo satinato temperato,
travi sottopiano in alluminio
*Executive desk with quad legs, tempered frosted glass top,
aluminium beams*

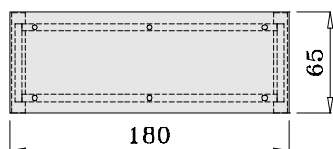

98	0,327	180	65	72,5	9VAL91.0030.71	rovere sbiancato/white oak
98	0,327	180	65	72,5	9VAL91.0030.72	rovere moka/mocha oak

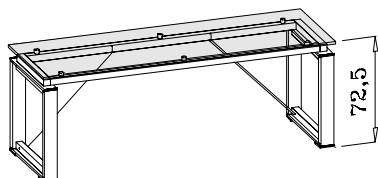

Scrivania direzionale con fianchi, piano in cristallo satinato temperato,
travi sottopiano in alluminio
*Executive desk with quad legs, tempered frosted glass top,
aluminium beams*

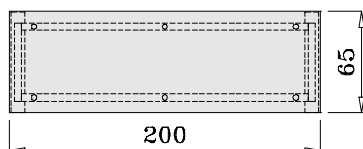

107,10	0,348	200	65	72,5	9VAL92.0030.71	rovere sbiancato/white oak
107,10	0,348	200	65	72,5	9VAL92.0030.72	rovere moka/mocha oak

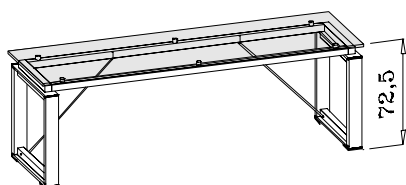

Scrivania direzionale con fianchi, piano in cristallo satinato temperato,
travi sottopiano in alluminio
*Executive desk with quad legs, tempered frosted glass top,
aluminium beams*

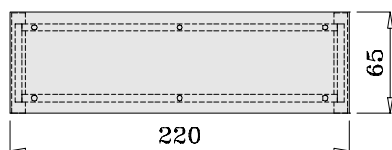

116,20	0,368	220	65	72,5	9VAL93.0030.71	rovere sbiancato/white oak
116,20	0,368	220	65	72,5	9VAL93.0030.72	rovere moka/mocha oak

ALLUNGI P. 65 IN ROVERE CON FIANCO • OAK PROLONGATIONS 65 D. WITH QUAD LEG

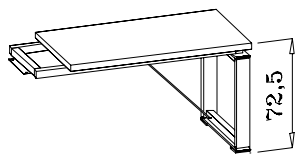

Allungo per scrivanie direzionali con fianco, piano in rovere,
travi sottopiano in alluminio
*Prolongation for executive desks with quad leg, oak top,
aluminium beams*

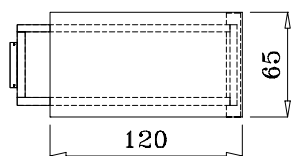

34	0,175	120	65	72,5	9VAL14.4501.71	rovere sbiancato/ <i>white oak</i>
34	0,175	120	65	72,5	9VAL14.4501.72	rovere moka/ <i>mocha oak</i>

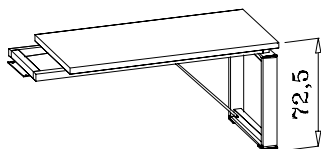

Allungo per scrivanie direzionali con fianco, piano in rovere,
travi sottopiano in alluminio
*Prolongation for executive desks with quad leg, oak top,
aluminium beams*

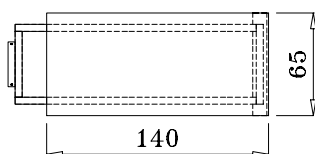

38,10	0,193	140	65	72,5	9VAL15.4501.71	rovere sbiancato/ <i>white oak</i>
38,10	0,193	140	65	72,5	9VAL15.4501.72	rovere moka/ <i>mocha oak</i>

ALLUNGHII P. 65 IN CRISTALLO CON FIANCO • GLASS TOP PROLONGATIONS 65 D. WITH QUAD LEG

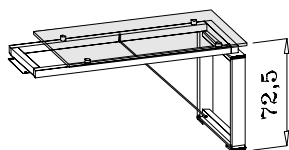

Allungo per scrivanie direzionali con fianco, piano in cristallo satinato temperato, travi sottopiano in alluminio
Prolongation for executive desks with quad legs, tempered frosted glass top, aluminium beams

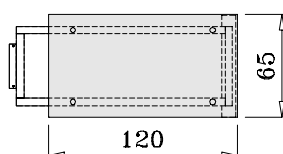

64,5	0,210	120	65	72,5	9VAL95.0030.71	rovere sbiancato/white oak
64,5	0,210	120	65	72,5	9VAL95.0030.72	rovere moka/mocha oak

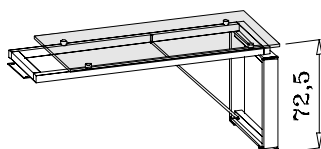

Allungo per scrivanie direzionali con fianco, piano in cristallo satinato temperato, travi sottopiano in alluminio
Prolongation for executive desks with quad legs, tempered frosted glass top, aluminium beams

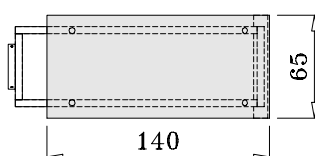

73,60	0,232	140	65	72,5	9VAL96.0030.71	rovere sbiancato/white oak
73,60	0,232	140	65	72,5	9VAL96.0030.72	rovere moka/mocha oak

TAVOLI RIUNIONE P. 120 CON FIANCHI • MEETING TABLES 120 D. WITH QUAD LEGS

Tavolo riunione con fianchi, piano in rovere,
travi sottopiano in alluminio
*Meeting table with quad legs, oak top,
aluminium beams*

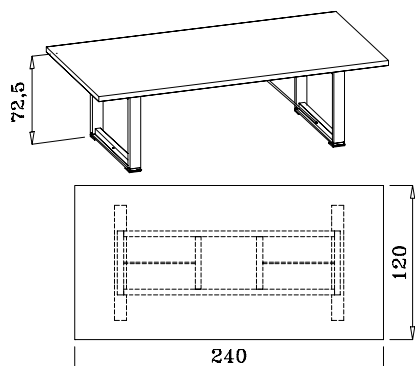

101,4	0,506	240	120	72,5	9VAL73.4501.71	rovere sbiancato/ <i>white oak</i>
101,4	0,506	240	120	72,5	9VAL73.4501.72	rovere moka/ <i>mocha oak</i>

Tavolo riunione con fianchi, piano in rovere,
travi sottopiano in alluminio
*Meeting table with quad legs, oak top,
aluminium beams*

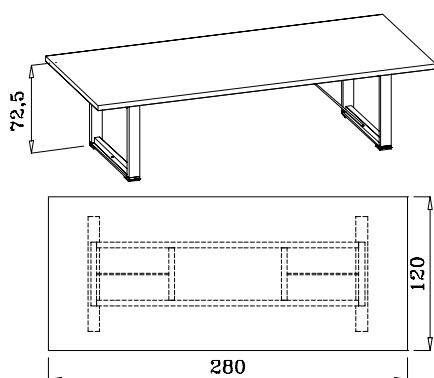

114,5	0,564	280	120	72,5	9VAL74.4501.71	rovere sbiancato/ <i>white oak</i>
114,5	0,564	280	120	72,5	9VAL74.4501.72	rovere moka/ <i>mocha oak</i>

Tavolo riunione con fianchi, piano in rovere,
travi sottopiano in alluminio
*Meeting table with quad legs, oak top,
aluminium beams*

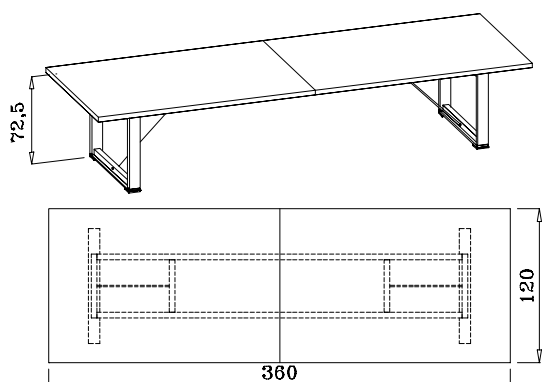

142	0,674	360	120	72,5	9VAL75.4501.71	rovere sbiancato/ <i>white oak</i>
142	0,674	360	120	72,5	9VAL75.4501.72	rovere moka/ <i>mocha oak</i>

SCRIVANIE P. 90 IN ROVERE CON GAMBE • OAK DESKS 90 D. WITH LEGS

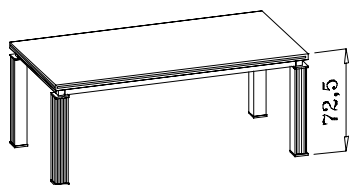

Scrivania direzionale con gambe, piano in rovere,
travi sottopiano in alluminio
*Executive desk with legs, oak top,
aluminium beams*

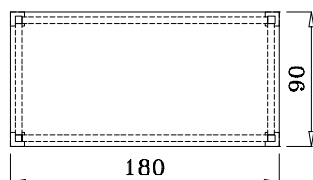

63,2	0,247	180	90	72,5	9VAN01.4501.71	rovere sbiancato/white oak
63,2	0,247	180	90	72,5	9VAN01.4501.72	rovere moka/mocha oak

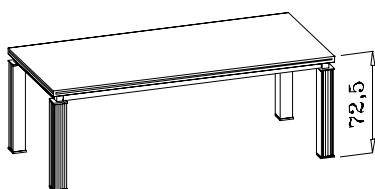

Scrivania direzionale con gambe, piano in rovere,
travi sottopiano in alluminio
*Executive desk with legs, oak top,
aluminium beams*

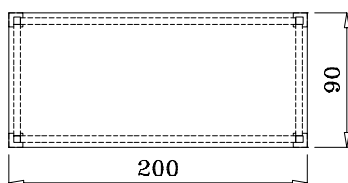

68,8	0,268	200	90	72,5	9VAN02.4501.71	rovere sbiancato/white oak
68,8	0,268	200	90	72,5	9VAN02.4501.72	rovere moka/mocha oak

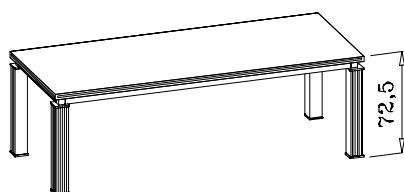

Scrivania direzionale con gambe, piano in rovere,
travi sottopiano in alluminio
*Executive desk with legs, oak top,
aluminium beams*

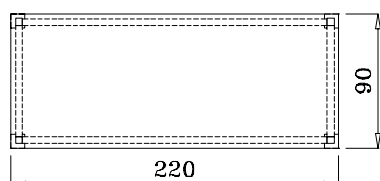

73,9	0,289	220	90	72,5	9VAN03.4501.71	rovere sbiancato/white oak
73,9	0,289	220	90	72,5	9VAN03.4501.72	rovere moka/mocha oak

SCRIVANIE P. 90 IN CRISTALLO CON GAMBE • GLASS TOP DESKS 90 D. WITH LEGS

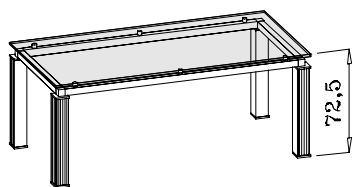

Scrivania direzionale con gambe, piano in cristallo satinato temperato,
travi sottopiano in alluminio
*Executive desk with legs, tempered frosted glass top,
aluminium beams*

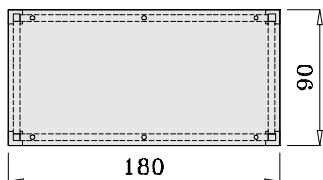

126,7	0,311	180	90	72,5	9VAN81.0030.71	rovere sbiancato/ <i>white oak</i>
126,7	0,311	180	90	72,5	9VAN81.0030.72	rovere moka/ <i>mocha oak</i>

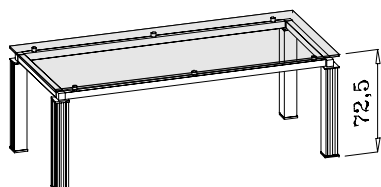

Scrivania direzionale con gambe, piano in cristallo satinato temperato,
travi sottopiano in alluminio
*Executive desk with legs, tempered frosted glass top,
aluminium beams*



139,3	0,339	200	90	72,5	9VAN82.0030.71	rovere sbiancato/ <i>white oak</i>
139,3	0,339	200	90	72,5	9VAN82.0030.72	rovere moka/ <i>mocha oak</i>

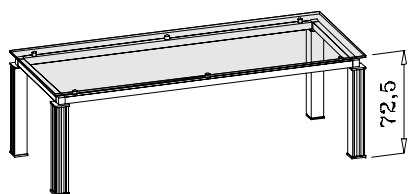

Scrivania direzionale con gambe, piano in cristallo satinato temperato,
travi sottopiano in alluminio
*Executive desk with legs, tempered frosted glass top,
aluminium beams*

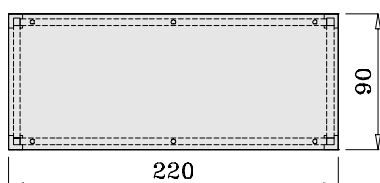

151,9	0,367	220	90	72,5	9VAN83.0030.71	rovere sbiancato/ <i>white oak</i>
151,9	0,367	220	90	72,5	9VAN83.0030.72	rovere moka/ <i>mocha oak</i>

SCRIVANIE P. 65 IN ROVERE CON GAMBE • OAK DESKS 65 D. WITH LEGS

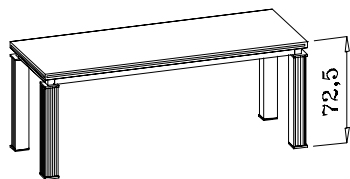

Scrivania direzionale con gambe, piano in rovere,
travi sottopiano in alluminio
*Executive desk with legs, oak top,
aluminium beams*

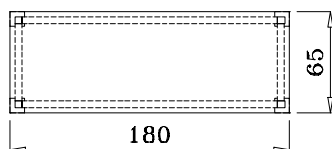

50,9	0,203	180	65	72,5	9VAN11.4501.71	rovere sbiancato/ <i>white oak</i>
50,9	0,203	180	65	72,5	9VAN11.4501.72	rovere moka/ <i>mocha oak</i>

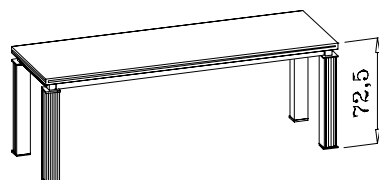

Scrivania direzionale con gambe, piano in rovere,
travi sottopiano in alluminio
*Executive desk with legs, oak top,
aluminium beams*

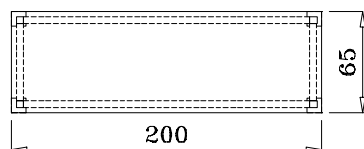

55	0,219	200	65	72,5	9VAN12.4501.71	rovere sbiancato/ <i>white oak</i>
55	0,219	200	65	72,5	9VAN12.4501.72	rovere moka/ <i>mocha oak</i>

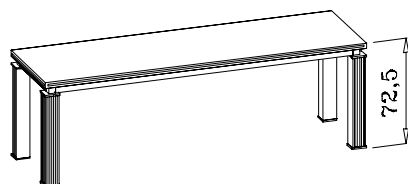

Scrivania direzionale con gambe, piano in rovere,
travi sottopiano in alluminio
*Executive desk with legs, oak top,
aluminium beams*

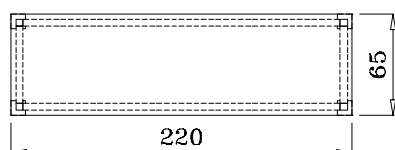

59,1	0,236	220	65	72,5	9VAN13.4501.71	rovere sbiancato/ <i>white oak</i>
59,1	0,236	220	65	72,5	9VAN13.4501.72	rovere moka/ <i>mocha oak</i>

SCRIVANIE P. 65 IN CRISTALLO CON GAMBE • GLASS TOP DESKS 65 D. WITH LEGS

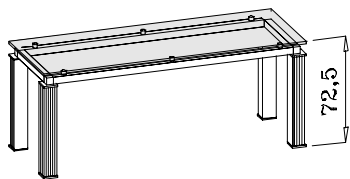

Scrivania direzionale con gambe, piano in cristallo satinato temperato,
travi sottopiano in alluminio
*Executive desk with legs, tempered frosted glass top,
aluminium beams*

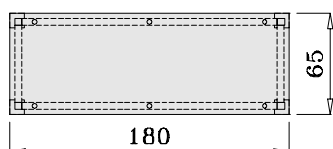

96,4	0,252	180	65	72,5	9VAN91.0030.71	rovere sbiancato/white oak
96,4	0,252	180	65	72,5	9VAN91.0030.72	rovere moka/mocha oak

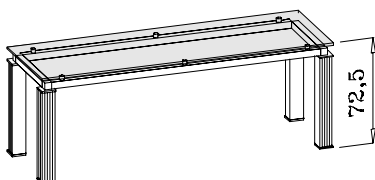

Scrivania direzionale con gambe, piano in cristallo satinato temperato,
travi sottopiano in alluminio
*Executive desk with legs, tempered frosted glass top,
aluminium beams*

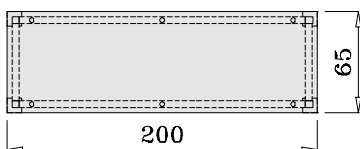

105,5	0,274	200	65	72,5	9VAN92.0030.71	rovere sbiancato/white oak
105,5	0,274	200	65	72,5	9VAN92.0030.72	rovere moka/mocha oak

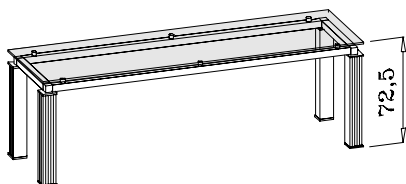

Scrivania direzionale con gambe, piano in cristallo satinato temperato,
travi sottopiano in alluminio
*Executive desk with legs, tempered frosted glass top,
aluminium beams*

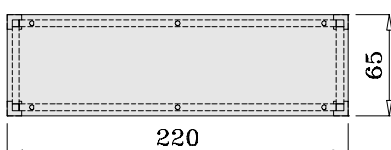

114,6	0,295	220	65	72,5	9VAN93.0030.71	rovere sbiancato/white oak
114,6	0,295	220	65	72,5	9VAN93.0030.72	rovere moka/mocha oak

ALLUNGI P. 65 IN ROVERE CON GAMBE • OAK PROLONGATIONS 65 D. WITH LEGS

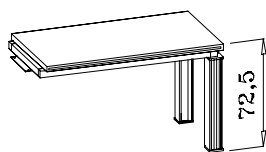

Allungo per scrivanie direzionali con gambe, piano in rovere,
travi sottopiano in alluminio
*Prolongation for executive desks with legs, oak top,
aluminium beams*

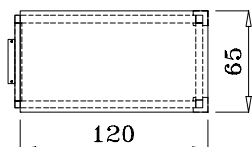

32,9	0,130	120	65	72,5	9VAN14.4501.71	rovere sbiancato/white oak
32,9	0,130	120	65	72,5	9VAN14.4501.72	rovere moka/mocha oak

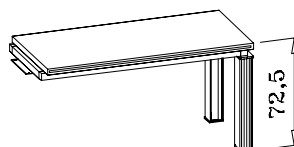

Allungo per scrivanie direzionali con gambe, piano in rovere,
travi sottopiano in alluminio
*Prolongation for executive desks with legs, oak top,
aluminium beams*

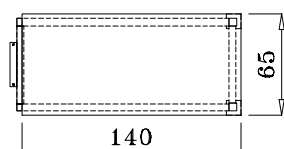

37	0,147	140	65	72,5	9VAN15.4501.71	rovere sbiancato/white oak
37	0,147	140	65	72,5	9VAN15.4501.72	rovere moka/mocha oak

ALLUNGI P. 65 IN CRISTALLO CON GAMBE • GLASS TOP PROLONGATIONS 65 D. WITH LEGS

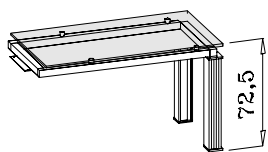

Allungo per scrivanie direzionali con gambe, piano in cristallo satinato temperato, travi sottopiano in alluminio
Prolongation for executive desks with legs, tempered frosted glass top, aluminium beams

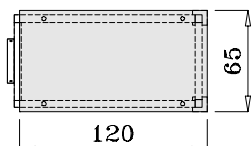

63,4	0,165	120	65	72,5	9VAN95.0030.71	rovere sbiancato/ <i>white oak</i>
63,4	0,165	120	65	72,5	9VAN95.0030.72	rovere moka/ <i>mocha oak</i>

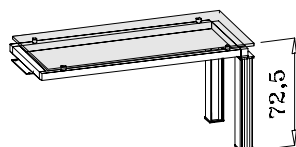

Allungo per scrivanie direzionali con gambe, piano in cristallo satinato temperato, travi sottopiano in alluminio
Prolongation for executive desks with legs, tempered frosted glass top, aluminium beams

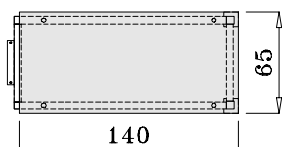

72,5	0,186	140	65	72,5	9VAN96.0030.71	rovere sbiancato/ <i>white oak</i>
72,5	0,186	140	65	72,5	9VAN96.0030.72	rovere moka/ <i>mocha oak</i>

TAVOLI RIUNIONE IN ROVERE CON GAMBE • OAK MEETING TABLES WITH LEGS

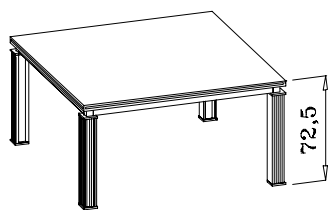

Tavolo riunione con gambe, piano in rovere,
travi sottopiano in alluminio
*Meeting table with legs, oak top,
aluminium beams*

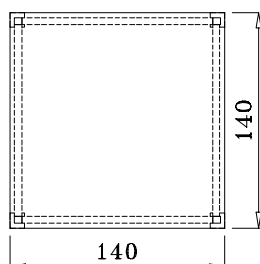

72,5	0,273	140	140	72,5	9VAN71.4501.71	rovere sbiancato/white oak
72,5	0,273	140	140	72,5	9VAN71.4501.72	rovere moka/mocha oak

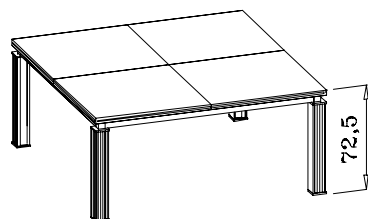

Tavolo riunione con gambe, piano in rovere,
travi sottopiano in alluminio
*Meeting table with legs, oak top,
aluminium beams*

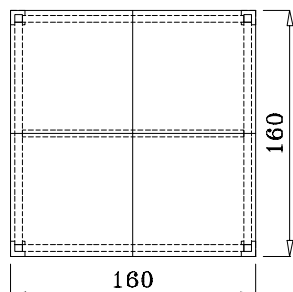

89,2	0,336	160	160	72,5	9VAN75.4501.71	rovere sbiancato/white oak
89,2	0,336	160	160	72,5	9VAN75.4501.72	rovere moka/mocha oak

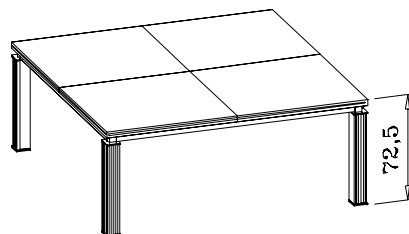

Tavolo riunione con gambe, piano in rovere,
travi sottopiano in alluminio
*Meeting table with legs, oak top,
aluminium beams*

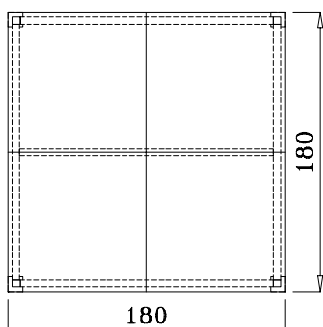

108,4	0,406	180	180	72,5	9VAN72.4501.71	rovere sbiancato/white oak
108,4	0,406	180	180	72,5	9VAN72.4501.72	rovere moka/mocha oak

TAVOLI RIUNIONE IN CRISTALLO CON GAMBE • GLASS TOP MEETING TABLES WITH LEGS

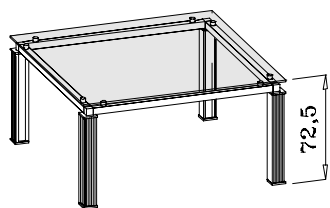

Tavolo riunione con gambe, piano in cristallo satinato temperato,
travi sottopiano in alluminio
*Meeting table with legs, tempered frosted glass top,
aluminium beams*

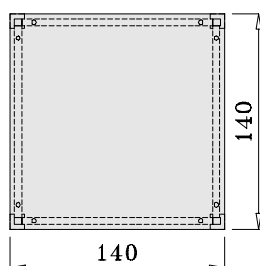

150	0,348	140	140	72,5	9VAN85.0030.71	rovere sbiancato/ <i>white oak</i>
150	0,348	140	140	72,5	9VAN85.0030.72	rovere moka/ <i>mocha oak</i>

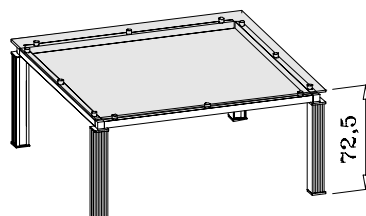

Tavolo riunione con gambe, piano in cristallo satinato temperato,
travi sottopiano in alluminio
*Meeting table with legs, tempered frosted glass top,
aluminium beams*

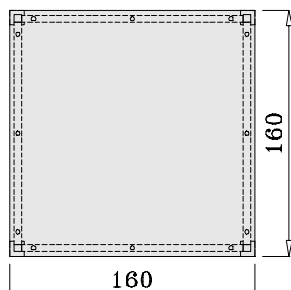

189,2	0,431	160	160	72,5	9VAN86.0030.71	rovere sbiancato/ <i>white oak</i>
189,2	0,431	160	160	72,5	9VAN86.0030.72	rovere moka/ <i>mocha oak</i>

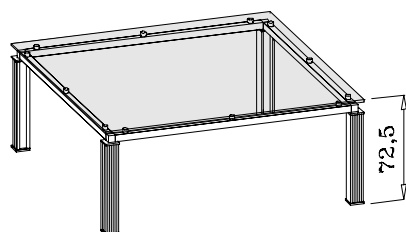

Tavolo riunione con gambe, piano in cristallo satinato temperato,
travi sottopiano in alluminio
*Meeting table with legs, tempered frosted glass top,
aluminium beams*

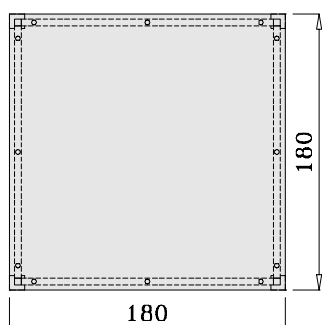

231,9	0,523	160	160	72,5	9VAN87.0030.71	rovere sbiancato/ <i>white oak</i>
231,9	0,523	160	160	72,5	9VAN87.0030.72	rovere moka/ <i>mocha oak</i>

TAVOLI RIUNIONE IN ROVERE CON GAMBE • OAK MEETING TABLES WITH LEGS

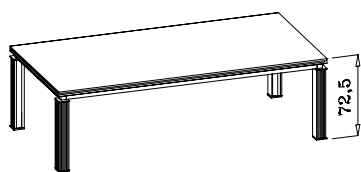

Tavolo riunione con gambe, piano in rovere,
travi sottopiano in alluminio
*Meeting table with legs, oak top,
aluminium beams*

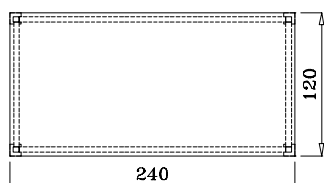

98,9	0,382	240	120	72,5	9VAN73.4501.71	rovere sbiancato/ <i>white oak</i>
98,9	0,382	240	120	72,5	9VAN73.4501.72	rovere moka/ <i>mocha oak</i>

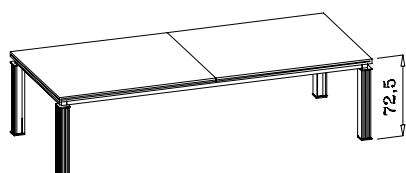

Tavolo riunione con gambe, piano in rovere,
travi sottopiano in alluminio
*Meeting table with legs, oak top,
aluminium beams*

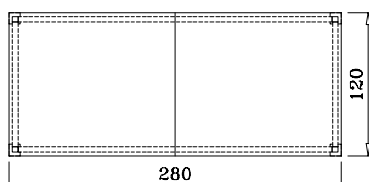

112,6	0,444	280	120	72,5	9VAN74.4501.71	rovere sbiancato/ <i>white oak</i>
112,6	0,444	280	120	72,5	9VAN74.4501.72	rovere moka/ <i>mocha oak</i>

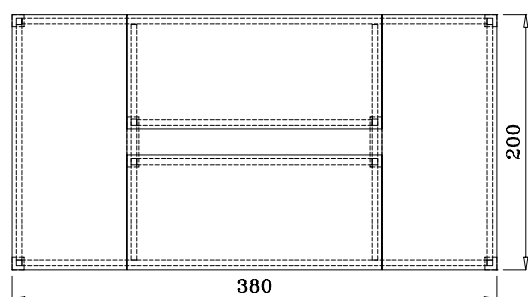

Tavolo riunione composto da 4 piani in rovere, 4 gambe laterali
e 2 gambe centrali, travi sottopiano in alluminio
*Meeting table composed of 4 oak tops, 4 lateral and 2 central legs,
aluminium beams*

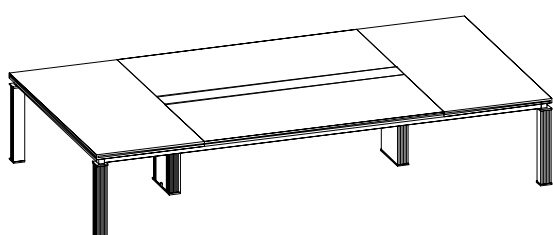

265,8	1,125	380	200	72,5	9VAK79.4501.71	rovere sbiancato/ <i>white oak</i>
265,8	1,125	380	200	72,5	9VAK79.4501.72	rovere moka/ <i>mocha oak</i>

GONNE PER SCRIVANIE • MODESTY PANELS FOR DESKS



Gonna in rovere per scrivanie l. 180.
Oak modesty panel for desks 180 w.

7,3	0,040	142	2	32	9VAQ10.4501.71	rovere sbiancato/ <i>white oak</i>
7,3	0,040	142	2	32	9VAQ10.4501.72	rovere moka/ <i>mocha oak</i>

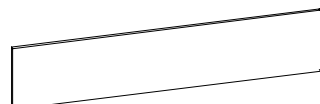

Gonna in rovere per scrivanie l. 200.
Oak modesty panel for desks 200 w.

8,3	0,045	162	2	32	9VAQ11.4501.71	rovere sbiancato/ <i>white oak</i>
8,3	0,045	162	2	32	9VAQ11.4501.72	rovere moka/ <i>mocha oak</i>

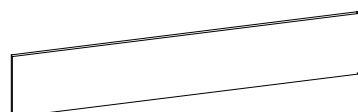

Gonna in rovere per scrivanie l. 220.
Oak modesty panel for desks 220 w.

9,3	0,050	182	2	32	9VAQ12.4501.71	rovere sbiancato/ <i>white oak</i>
9,3	0,050	182	2	32	9VAQ12.4501.72	rovere moka/ <i>mocha oak</i>

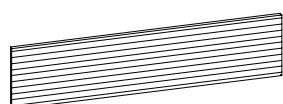

Gonna in alluminio "millerighe" per scrivanie l. 180.
Striped aluminium modesty panel for desks 180 w.

8,4	0,040	142	2	32	9VAQ10.0008	alluminio/ <i>aluminium</i>
-----	-------	-----	---	----	--------------------	-----------------------------

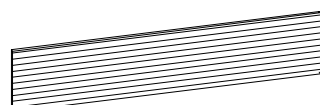

Gonna in alluminio "millerighe" per scrivanie l. 200.
Striped aluminium modesty panel for desks 200 w.

9,6	0,045	162	2	32	9VAQ11.0008	alluminio/ <i>aluminium</i>
-----	-------	-----	---	----	--------------------	-----------------------------

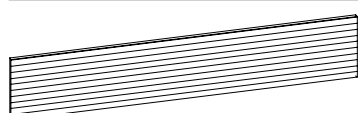

Gonna in alluminio "millerighe" per scrivanie l. 220.
Striped aluminium modesty panel for desks 220 w.

10,8	0,050	182	2	32	9VAQ12.0008	alluminio/ <i>aluminium</i>
------	-------	-----	---	----	--------------------	-----------------------------



Sistema Axial 3 composto da 1 presa Italia + 1 presa Schuko + 1 Dati RJ45 Cat. 5 schermata .
Axial 3 system composed of 1 Italian socket + 1 Schuko socket + 1 Datas RJ45 Cat. 5 screen.

9VHAZX5400



Sistema Turn 3 composto da 1 presa Italia + 1 presa Schuko + 1 Dati RJ45 Cat. 5 schermata .
Turn 3 system composed of 1 Italian socket + 1 Schuko socket + 1 Datas RJ45 Cat. 5 screen.

9VHAZJ040

Cavo alimentazione rete elettrica Mt. 4 con presa Schuko
Electric cable for feeding mt. 4 with Schuko socket.

9VHD602400

Su richiesta disponibili nelle versioni internazionali. *Available upon request in the international versions.*

CASSETTIERE E PORTACOMPUTERS • PEDESTALS AND COMPUTER HOLDERS



Cassettiera con un portacancelleria e tre cassetti, con serratura. Struttura melaminico finitura alluminio, fianchi di finitura e tops impiallacciati rovere. Piedini regolabili con piastra in alluminio. (* cassetti interni in laminato plastico)
Pedestal with one stationery tray and three drawers, with lock. Melamine structure in aluminium colour, sides and tops in oak veneer. Adjustable feet mounted on aluminium plates.
(* internal drawers in PVC)

59,1	0,307	58	65	63,7	9VBN03.4501.71	rovere sbiancato/white oak
59,1	0,307	58	65	63,7	9VBN03.4501.72	rovere moka/mocha oak
* 59,1	0,307	58	65	63,7	9VBN03.4502.71	rovere sbiancato/white oak
* 59,1	0,307	58	65	63,7	9VBN03.4502.72	rovere moka/mocha oak



Cassettiera con un portacancelleria, un cassetto ed un portacartelle, con serratura. Struttura melaminico finitura alluminio, fianchi di finitura e tops impiallacciati rovere. Piedini regolabili con piastra in alluminio. (* cassetti interni in laminato plastico)
Pedestal with one stationery tray, one drawer and one filing drawer, with lock. Melamine structure in aluminium colour, sides and tops in oak veneer. Adjustable feet mounted on aluminium plates. (* internal drawers in PVC)

57,5	0,307	58	65	63,7	9VBN04.4501.71	rovere sbiancato/white oak
57,5	0,307	58	65	63,7	9VBN04.4501.72	rovere moka/mocha oak
* 57,5	0,307	58	65	63,7	9VBN04.4502.71	rovere sbiancato/white oak
* 57,5	0,307	58	65	63,7	9VBN04.4502.72	rovere moka/mocha oak

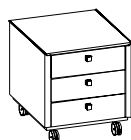

Cassettiera su ruote con tre cassetti, con serratura. Struttura melaminico finitura alluminio, fianchi di finitura e tops impiallacciati rovere. (* cassetti interni in laminato plastico)
Pedestal on castors with three drawers, with lock. Melamine structure in aluminium colour, sides and tops in oak veneer. (* internal drawers in PVC)

51	0,307	58	65	62,3	9VBN01.4501.71	rovere sbiancato/white oak
51	0,307	58	65	62,3	9VBN01.4501.72	rovere moka/mocha oak
* 51	0,307	58	65	62,3	9VBN01.4502.71	rovere sbiancato/white oak
* 51	0,307	58	65	62,3	9VBN01.4502.72	rovere moka/mocha oak

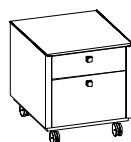

Cassettiera su ruote con un cassetto ed un portacartelle, con serratura. Struttura melaminico finitura alluminio, fianchi di finitura e tops impiallacciati rovere. (* cassetti interni in laminato plastico)
Pedestal on castors with one drawer and one filing drawer, with lock. Melamine structure in aluminium colour, sides and tops in oak veneer. (* internal drawers in PVC)

49,4	0,307	58	65	62,3	9VBN02.4501.71	rovere sbiancato/white oak
49,4	0,307	58	65	62,3	9VBN02.4501.72	rovere moka/mocha oak
* 49,4	0,307	58	65	62,3	9VBN02.4502.71	rovere sbiancato/white oak
* 49,4	0,307	58	65	62,3	9VBN02.4502.72	rovere moka/mocha oak

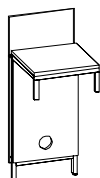

Portacomputer su piedi.
Struttura formata da travi in alluminio, schiena e piano impiallacciati rovere
Computer holder on feet.
Structure made by aluminium beams, back and top in oak veneer.

16,8	0,292	40	43,5	100	9VAQ01.4501.71	rovere sbiancato/white oak
16,8	0,292	40	43,5	100	9VAQ01.4501.72	rovere moka/mocha oak

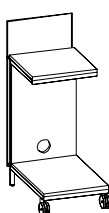

Portacomputer su ruote.
Struttura formata da travi in alluminio, schiena e piano impiallacciati rovere
Computer holder on castors.
Structure made by aluminium beams, back and top in oak veneer.

22,3	0,292	40	63	100	9VAQ02.4501.71	rovere sbiancato/white oak
22,3	0,292	40	63	100	9VAQ02.4501.72	rovere moka/mocha oak

CONTENITORI DI SERVIZIO H. 63,7 - P. 65 • STORAGE UNITS 63,7 H. - 65 D.

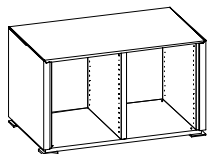

Per ottenere soluzioni personalizzate
vedi pag. 34

In order to obtain a personalized
solution, please look at page 34

Contenitore di servizio aperto con due vani l. 46,4.
Struttura melaminico finitura alluminio, fianchi di finitura e tops impiallacciati rovere.
Piedini regolabili con piastre in alluminio.
*Open storage unit with two 46,4 w. compartments.
Melamine structure in aluminium colour, sides and tops in oak veneer. Adjustable feet
mounted on aluminium plates.*

72,4	0,285	107,9	65	63,7	9VBN12.4501.71	rovere sbiancato/white oak
72,4	0,285	107,9	65	63,7	9VBN12.4501.72	rovere moka/mocha oak

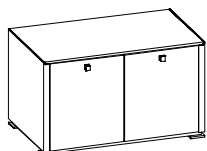

Contenitore di servizio con 2 ante, con serratura.
Storage unit with 2 doors, with lock.

92,6	0,365	107,9	65	63,7	9VBN12.4501.71A	rovere sbiancato/white oak
92,6	0,365	107,9	65	63,7	9VBN12.4501.72A	rovere moka/mocha oak

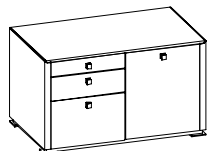

Contenitore di servizio con 1 portacancelleria, 1 cassetto, 1 portacartelle e 1 anta,
con serrature.
Storage unit with a stationery tray, a drawer, a filing drawer and a door, with locks.

92,7	0,632	107,9	65	63,7	9VBN12.4501.71B	rovere sbiancato/white oak
92,7	0,632	107,9	65	63,7	9VBN12.4501.72B	rovere moka/mocha oak

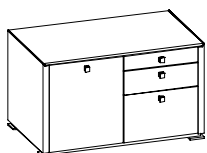

Contenitore di servizio con 1 anta, 1 portacancelleria, 1 cassetto e 1 portacartelle,
con serrature.
Storage unit with a door, a stationery tray, a drawer, and a filing drawer, with locks.

92,7	0,632	107,9	65	63,7	9VBN12.4501.71C	rovere sbiancato/white oak
92,7	0,632	107,9	65	63,7	9VBN12.4501.72C	rovere moka/mocha oak

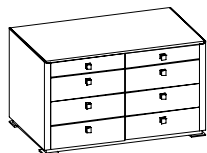

Contenitore di servizio con 2 portacancelleria e 6 cassetti, con serrature.
Storage unit with 2 stationery trays and 6 drawers, with locks.

96,0	0,899	107,9	65	63,7	9VBN12.4501.71D	rovere sbiancato/white oak
96,0	0,899	107,9	65	63,7	9VBN12.4501.72D	rovere moka/mocha oak

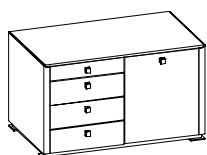

Contenitore di servizio con 1 portacancelleria, 3 cassetti e 1 anta, con serrature.
Storage unit with a stationery tray, 3 drawers and a door, with locks.

94,3	0,632	107,9	65	63,7	9VBN12.4501.71E	rovere sbiancato/white oak
94,3	0,632	107,9	65	63,7	9VBN12.4501.72E	rovere moka/mocha oak

CONTENITORI DI SERVIZIO H. 63,7 - P. 65 • STORAGE UNITS 63,7 H. - 65 D.

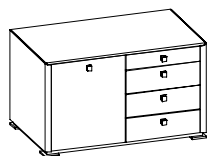

Contenitore di servizio con 1 anta, 1 portacancelleria e 3 cassetti, con serrature.
Storage unit with a door, a stationery tray and 3 drawers, with locks.

94,3	0,632	107,9	65	63,7	9VBN12.4501.71F	rovere sbiancato/ <i>white oak</i>
94,3	0,632	107,9	65	63,7	9VBN12.4501.72F	rovere moka/ <i>mocha oak</i>

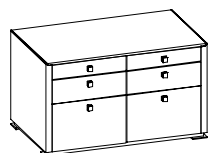

Contenitore di servizio con 2 portacancelleria, 2 cassetti e 2 portacartelle,
con serrature.
Storage unit with 2 stationery trays, 2 drawers and 2 filing drawers, with locks.

97,4	0,923	107,9	65	63,7	9VBN12.4501.71G	rovere sbiancato/ <i>white oak</i>
97,4	0,923	107,9	65	63,7	9VBN12.4501.72G	rovere moka/ <i>mocha oak</i>

CONTENITORI DI SERVIZIO H. 63,7 - P. 65 • STORAGE UNITS 63,7 H. - 65 D.

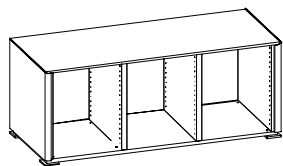

Per ottenere soluzioni personalizzate vedi pag. 34

In order to obtain a personalized solution, please look at page 34

Contenitore di servizio aperto con tre vani l. 46,4.
Struttura melaminico finitura alluminio, fianchi di finitura e tops impiallacciati rovere.
Piedini regolabili con piastre in alluminio.
*Open storage unit with three 46,4 w. compartments.
Melamine structure in aluminium colour, sides and tops in oak veneer. Adjustable feet mounted on aluminium plates.*

97,4	0,381	157,8	65	63,7	9VBN14.4501.71	rovere sbiancato/white oak
97,4	0,381	157,8	65	63,7	9VBN14.4501.72	rovere moka/mocha oak

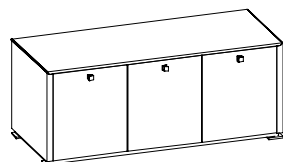

Contenitore di servizio con 3 ante, con serrature.
Storage unit with 3 doors, with locks.

127,7	0,501	157,8	65	63,7	9VBN14.4501.71A	rovere sbiancato/white oak
127,7	0,501	157,8	65	63,7	9VBN14.4501.72A	rovere moka/mocha oak

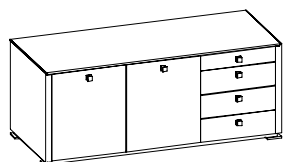

Contenitore di servizio con 2 ante, 1 portacancelleria e 3 cassetti, con serrature.
Storage unit with 2 doors, a stationery tray and 3 drawers, with locks.

129,4	0,768	157,8	65	63,7	9VBN14.4501.71B	rovere sbiancato/white oak
129,4	0,768	157,8	65	63,7	9VBN14.4501.72B	rovere moka/mocha oak

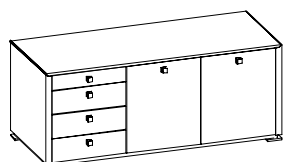

Contenitore di servizio con 1 portacancelleria, 3 cassetti e 2 ante, con serrature.
Storage unit with a stationery tray, 3 drawers and 2 doors, with locks.

129,4	0,768	157,8	65	63,7	9VBN14.4501.71C	rovere sbiancato/white oak
129,4	0,768	157,8	65	63,7	9VBN14.4501.72C	rovere moka/mocha oak

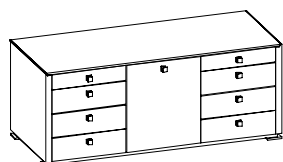

Contenitore di servizio con 2 portacancelleria, 6 cassetti e 1 anta, con serrature.
Storage unit with 2 stationery trays, 6 drawers and a door, with locks.

131,1	1,035	157,8	65	63,7	9VBN14.4501.71D	rovere sbiancato/white oak
131,1	1,035	157,8	65	63,7	9VBN14.4501.72D	rovere moka/mocha oak

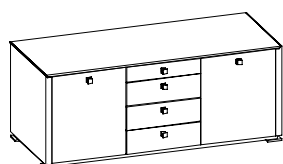

Contenitore di servizio con 1 portacancelleria, 3 cassetti e 2 ante, con serrature.
Storage unit with a stationery tray, 3 drawers and 2 doors, with locks.

129,4	0,768	157,8	65	63,7	9VBN14.4501.71E	rovere sbiancato/white oak
129,4	0,768	157,8	65	63,7	9VBN14.4501.72E	rovere moka/mocha oak

CONTENITORI DI SERVIZIO H. 63,7 - P. 65 • STORAGE UNITS 63,7 H. - 65 D.

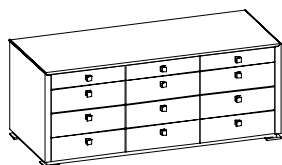

Contenitore di servizio con 3 portacancelleria e 9 cassetti, con serrature.
Storage unit with 3 stationery trays and 9 drawers, with locks.

132,8	1,302	157,8	65	63,7	9VBN14.4501.71F	rovere sbiancato/white oak
132,8	1,302	157,8	65	63,7	9VBN14.4501.72F	rovere moka/mocha oak

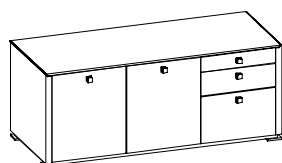

Contenitore di servizio con 2 ante, 1 portacancelleria, 1 cassetto e 1 portacartelle, con serrature.
Storage unit with 2 doors, a stationery tray, 1 drawer and 1 filing drawer, with locks.

127,8	0,768	157,8	65	63,7	9VBN14.4501.71G	rovere sbiancato/white oak
127,8	0,768	157,8	65	63,7	9VBN14.4501.72G	rovere moka/mocha oak

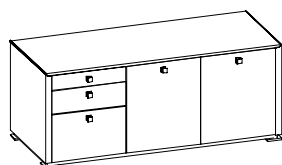

Contenitore di servizio con 1 portacancelleria, 1 cassetto, 1 portacartelle e 2 ante, con serrature.
Storage unit with a stationery tray, 1 drawer, 1 filing drawer and 2 doors, with locks.

127,8	0,768	157,8	65	63,7	9VBN14.4501.71H	rovere sbiancato/white oak
127,8	0,768	157,8	65	63,7	9VBN14.4501.72H	rovere moka/mocha oak

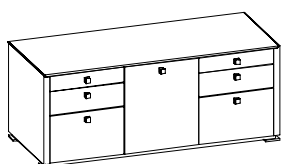

Contenitore di servizio con 2 portacancelleria, 2 cassetti, 2 portacartelle e 1 anta, con serrature.
Storage unit with 2 stationery trays, 2 drawers, 2 filing drawers and a door, with locks.

127,9	1,035	157,8	65	63,7	9VBN14.4501.71I	rovere sbiancato/white oak
127,9	1,035	157,8	65	63,7	9VBN14.4501.72I	rovere moka/mocha oak

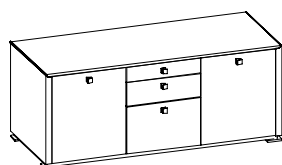

Contenitore di servizio con 2 ante, 1 portacancelleria, 1 cassetto e 1 portacartelle, con serrature.
Storage unit with 2 doors, a stationery tray, 1 drawer and 1 filing drawer, with locks.

127,8	0,768	157,8	65	63,7	9VBN14.4501.71L	rovere sbiancato/white oak
127,8	0,768	157,8	65	63,7	9VBN14.4501.72L	rovere moka/mocha oak

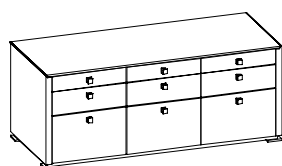

Contenitore di servizio con 3 portacancelleria, 3 cassetti e 3 portacartelle, con serrature.
Storage unit with 3 stationery trays, 3 drawers and 3 filing drawers, with locks.

128,0	1,302	157,8	65	63,7	9VBN14.4501.71M	rovere sbiancato/white oak
128,0	1,302	157,8	65	63,7	9VBN14.4501.72M	rovere moka/mocha oak

COMPONENTI PER CONTENITORI DI SERVIZIO • COMPONENTS FOR STORAGE UNITS

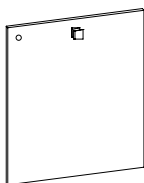

Anta rovere destra con serratura
Right oak door with lock

4,6	0,024	49,6	57,9	2	9VBA11.4501.71	rovere sbiancato/white oak
4,6	0,024	49,6	57,9	2	9VBA11.4501.72	rovere moka/mocha oak

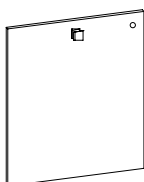

Anta rovere sinistra con serratura
Left oak door with lock

4,6	0,024	49,6	57,9	2	9VBA11.4511.71	rovere sbiancato/white oak
4,6	0,024	49,6	57,9	2	9VBA11.4511.72	rovere moka/mocha oak

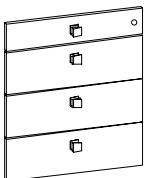

N.1 portacancelleria + n. 3 cassetti per vano l. 46,4, con serratura
A stationery tray + 3 drawers for compartment 46,4 w., with lock

11,8	0,307	49,6	57,9	2	9VBX03.4501.71	rovere sbiancato/white oak
11,8	0,307	49,6	57,9	2	9VBX03.4501.72	rovere moka/mocha oak

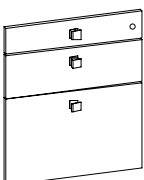

N.1 portacancelleria + n. 1 cassetto + n. 1 portacartelle per vano l. 46,4, con serratura
A stationery tray + a drawer + a filing drawer for compartment 46,4 w., with lock

10,2	0,307	49,6	57,9	2	9VBX04.4501.71	rovere sbiancato/white oak
10,2	0,307	49,6	57,9	2	9VBX04.4501.72	rovere moka/mocha oak

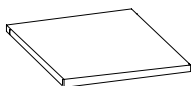

Ripiano interno per vano l. 464
Internal shelf for compartment 46,4 w.

5,5	0,016	46,4	59,5	2,5	9VBR01.4801.80	mel. alluminio/mel. aluminium
-----	-------	------	------	-----	-----------------------	-------------------------------

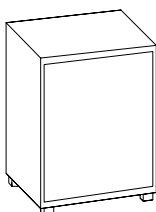

Mini Cool.

42,5	37,3	46,5	9QZEA.3080.3	lt. 23
42,5	37,3	58,0	9QZEA.3120.3	lt. 31

CONTENITORI H. 82,2 - P. 46,5 • STORAGE UNITS 82,2 H. - 46,5 W.

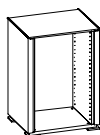

Contenitore aperto con vano l. 46,4.
Struttura melaminico finitura alluminio, fianchi di finitura e tops impiallacciati rovere.
Piedini regolabili con piastre in alluminio.
*Open storage unit with a 46,4 w. compartment.
Melamine structure in aluminium colour, sides and tops in oak veneer. Adjustable feet mounted on aluminium plates.*

Per ottenere soluzioni personalizzate
vedi pag. 44

*In order to obtain a personalized
solution, please look at page 44*

43,3	0,184	58	46,5	82,2	9VCN01.4501.71	rovere sbiancato/white oak
43,3	0,184	58	46,5	82,2	9VCN01.4501.72	rovere moka/mocha oak

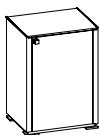

Contenitore destro con 1 anta.
Right storage unit with a door.

53,2	0,226	58	46,5	82,2	9VCN01.4501.71A	rovere sbiancato/white oak
53,2	0,226	58	46,5	82,2	9VCN01.4501.72A	rovere moka/mocha oak

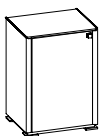

Contenitore sinistro con 1 anta.
Left storage unit with a door.

53,2	0,226	58	46,5	82,2	9VCN01.4501.71B	rovere sbiancato/white oak
53,2	0,226	58	46,5	82,2	9VCN01.4501.72B	rovere moka/mocha oak

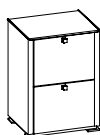

Contenitore con 2 portacartelle.
Storage unit with 2 filing drawers.

57,1	0,442	58	46,5	82,2	9VCN01.4501.71C	rovere sbiancato/white oak
57,1	0,442	58	46,5	82,2	9VCN01.4501.72C	rovere moka/mocha oak

CONTENITORI H. 82,2 - P. 46,5 • STORAGE UNITS 82,2 H. - 46,5 W.

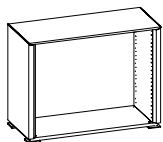

Contenitore aperto con vano l. 96,3.
Struttura melaminico finitura alluminio, fianchi di finitura e tops impiallacciati rovere.
Piedini regolabili con piastre in alluminio.
*Open storage unit with a 96,3 w. compartment.
Melamine structure in aluminium colour, sides and tops in oak veneer. Adjustable feet mounted on aluminium plates.*

Per ottenere soluzioni personalizzate
vedi pag. 44

*In order to obtain a personalized
solution, please look at page 44*

56,5	0,238	107,9	46,5	82,2	9VCN02.4501.71	rovere sbiancato/white oak
56,5	0,238	107,9	46,5	82,2	9VCN02.4501.72	rovere moka/mocha oak

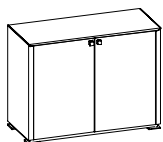

Contenitore con 2 ante.
Storage unit with 2 doors.

76,4	0,322	107,9	46,5	82,2	9VCN02.4501.71A	rovere sbiancato/white oak
76,4	0,322	107,9	46,5	82,2	9VCN02.4501.72A	rovere moka/mocha oak

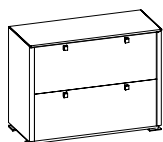

Contenitore con 2 portacartelle.
Storage unit with 2 filing drawers.

82,5	0,728	107,9	46,5	82,2	9VCN02.4501.71B	rovere sbiancato/white oak
82,5	0,728	107,9	46,5	82,2	9VCN02.4501.72B	rovere moka/mocha oak

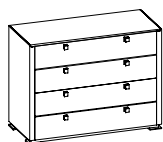

Contenitore con 4 cassetti.
Storage unit with 4 drawers.

78,5	0,770	107,9	46,5	82,2	9VCN02.4501.71C	rovere sbiancato/white oak
78,5	0,770	107,9	46,5	82,2	9VCN02.4501.72C	rovere moka/mocha oak

CONTENITORI H. 82,2 - P. 46,5 • STORAGE UNITS 82,2 H. - 46,5 W.

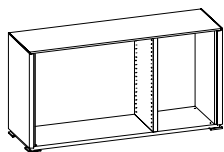

Per ottenere soluzioni personalizzate vedi pag. 44

In order to obtain a personalized solution, please look at page 44

Contenitore destro aperto con un vano l. 46,4 ed un vano l. 96,3.
Struttura melaminico finitura alluminio, fianchi di finitura e tops impiallacciati rovere.
Piedini regolabili con piastre in alluminio.
*Right open storage unit with a 46,4 w. compartment and a 96,3 w. compartment.
Melamine structure in aluminium colour, sides and tops in oak veneer. Adjustable feet mounted on aluminium plates.*

79,0	0,304	157,8	46,5	82,2	9VCN04.4501.71	rovere sbiancato/white oak
79,0	0,304	157,8	46,5	82,2	9VCN04.4501.72	rovere moka/mocha oak

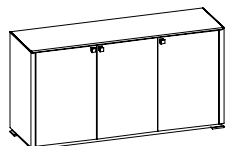

Contenitore con 3 ante.
Storage unit with 3 doors.

108,8	0,430	157,8	46,5	82,2	9VCN04.4501.71A	rovere sbiancato/white oak
108,8	0,430	157,8	46,5	82,2	9VCN04.4501.72A	rovere moka/mocha oak

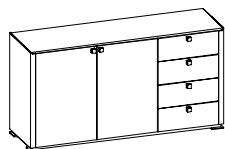

Contenitore con 2 ante e 4 cassetti.
Storage unit with 2 doors and 4 drawers.

111,7	0,668	157,8	46,5	82,2	9VCN04.4501.71B	rovere sbiancato/white oak
111,7	0,668	157,8	46,5	82,2	9VCN04.4501.72B	rovere moka/mocha oak

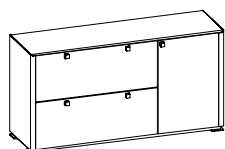

Contenitore con 2 portacartelle e 1 anta.
Storage unit with 2 filing drawers and a door.

114,9	0,836	157,8	46,5	82,2	9VCN04.4501.71C	rovere sbiancato/white oak
114,9	0,836	157,8	46,5	82,2	9VCN04.4501.72C	rovere moka/mocha oak

CONTENITORI H. 82,2 - P. 46,5 • STORAGE UNITS 82,2 H. - 46,5 W.



Per ottenere soluzioni personalizzate vedi pag. 44

In order to obtain a personalized solution, please look at page 44

Contenitore sinistro aperto con un vano l. 46,4 ed un vano l. 96,3.
Struttura melaminico finitura alluminio, fianchi di finitura e tops impiallacciati rovere.
Piedini regolabili con piastre in alluminio.
*Left open storage unit with a 46,4 w. compartment and a 96,3 w. compartment.
Melamine structure in aluminium colour, sides and tops in oak veneer. Adjustable feet mounted on aluminium plates.*

79,0	0,304	157,8	46,5	82,2	9VCN04.4511.71	rovere sbiancato/white oak
79,0	0,304	157,8	46,5	82,2	9VCN04.4511.72	rovere moka/mocha oak

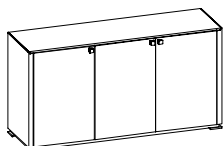

Contenitore con 3 ante.
Storage unit with 3 doors.

108,8	0,430	157,8	46,5	82,2	9VCN04.4511.71A	rovere sbiancato/white oak
108,8	0,430	157,8	46,5	82,2	9VCN04.4511.72A	rovere moka/mocha oak

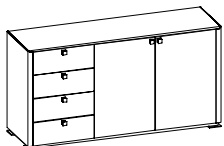

Contenitore con 4 cassetti e 2 ante.
Storage unit with 4 drawers and 2 doors.

111,7	0,668	157,8	46,5	82,2	9VCN04.4511.71B	rovere sbiancato/white oak
111,7	0,668	157,8	46,5	82,2	9VCN04.4511.72B	rovere moka/mocha oak

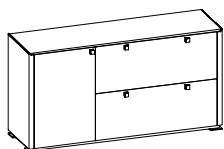

Contenitore con 1 anta e 2 portacartelle.
Storage unit with a door and 2 filing drawers.

114,9	0,836	157,8	46,5	82,2	9VCN04.4511.71C	rovere sbiancato/white oak
114,9	0,836	157,8	46,5	82,2	9VCN04.4511.72C	rovere moka/mocha oak

CONTENITORI H. 82,2 - P. 46,5 • STORAGE UNITS 82,2 H. - 46,5 W.

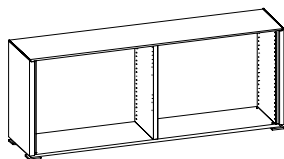

Per ottenere soluzioni personalizzate
vedi pag. 44

In order to obtain a personalized
solution, please look at page 44

Contenitore aperto con due vani l. 96,3.
Struttura melaminico finitura alluminio, fianchi di finitura e tops impiallacciati rovere.
Piedini regolabili con piastre in alluminio.
*Open storage unit with two 96,3 w. compartments.
Melamine structure in aluminium colour, sides and tops in oak veneer. Adjustable feet
mounted on aluminium plates.*

92,2	0,329	207,7	46,5	82,2	9VCN06.4501.71	rovere sbiancato/white oak
92,2	0,329	207,7	46,5	82,2	9VCN06.4501.72	rovere moka/mocha oak

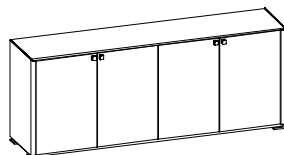

Contenitore con 4 ante.
Storage unit with 4 doors.

132,0	0,497	207,7	46,5	82,2	9VCN06.4501.71A	rovere sbiancato/white oak
132,0	0,497	207,7	46,5	82,2	9VCN06.4501.72A	rovere moka/mocha oak

CONTENITORI H. 82,2 - P. 46,5 • STORAGE UNITS 82,2 H. - 46,5 W.

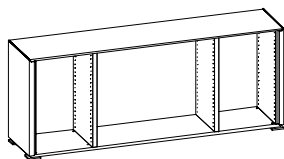

Per ottenere soluzioni personalizzate
vedi pag. 44

In order to obtain a personalized
solution, please look at page 44

Contenitore aperto con due vani l. 46,4 ed un vano l. 96,3.
Struttura melaminico finitura alluminio, fianchi di finitura e tops impiallacciati rovere.
Piedini regolabili con piastre in alluminio.
*Open storage unit with two 46,4 w. compartments and a 96,3 w. compartment.
Melamine structure in aluminium colour, sides and tops in oak veneer. Adjustable feet
mounted on aluminium plates.*

101,6	0,369	207,7	46,5	82,2	9VCN07.4501.71	rovere sbiancato/white oak
101,6	0,369	207,7	46,5	82,2	9VCN07.4501.72	rovere moka/mocha oak

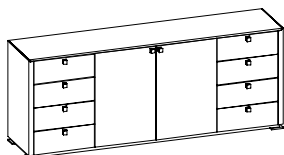

Contenitore 8 cassetti e 2 ante.
Storage unit with 8 drawers and 2 doors.

147,1	1,013	207,7	46,5	82,2	9VCN07.4501.71A	rovere sbiancato/white oak
147,1	1,013	207,7	46,5	82,2	9VCN07.4501.72A	rovere moka/mocha oak

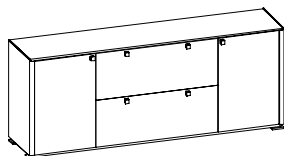

Contenitore 2 ante e 2 portacartelle.
Storage unit with 2 doors and 2 filing drawers.

147,4	0,943	207,7	46,5	82,2	9VCN07.4501.71B	rovere sbiancato/white oak
147,4	0,943	207,7	46,5	82,2	9VCN07.4501.72B	rovere moka/mocha oak

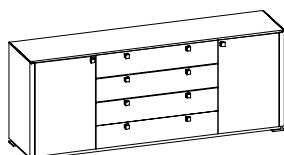

Contenitore 2 ante e 4 cassetti.
Storage unit with 2 doors and 4 drawers.

143,4	0,985	207,7	46,5	82,2	9VCN07.4501.71C	rovere sbiancato/white oak
143,4	0,985	207,7	46,5	82,2	9VCN07.4501.72C	rovere moka/mocha oak

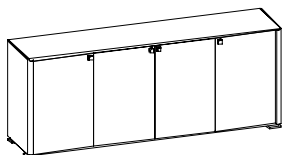

Contenitore 4 ante.
Storage unit with 4 doors.

141,3	0,537	207,7	46,5	82,2	9VCN07.4501.71D	rovere sbiancato/white oak
141,3	0,537	207,7	46,5	82,2	9VCN07.4501.72D	rovere moka/mocha oak

CONTENITORI H. 82,2 - P. 46,5 • STORAGE UNITS 82,2 H. - 46,5 W.

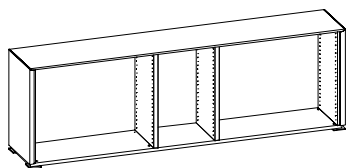

Per ottenere soluzioni personalizzate vedi pag. 44

In order to obtain a personalized solution, please look at page 44

Contenitore aperto con un vano l. 46,4 e due vani l. 96,3.

Struttura melaminico finitura alluminio, fianchi di finitura e tops impiallacciati rovere. Piedini regolabili con piastre in alluminio.

Open storage unit with a 46,4 w. compartment and two 96,3 w. compartments. Melamine structure in aluminium colour, sides and tops in oak veneer. Adjustable feet mounted on aluminium plates.

114,8	0,584	257,6	46,5	82,2	9VCN08.4501.71	rovere sbiancato/white oak
114,8	0,584	257,6	46,5	82,2	9VCN08.4501.72	rovere moka/mocha oak

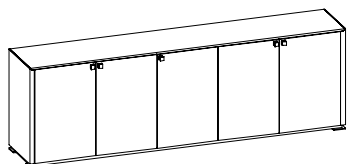

Contenitore con 5 ante.

Storage unit with 5 doors.

164,5	0,794	257,6	46,5	82,2	9VCN08.4501.71A	rovere sbiancato/white oak
164,5	0,794	257,6	46,5	82,2	9VCN08.4501.72A	rovere moka/mocha oak

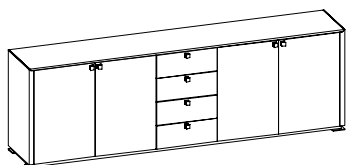

Contenitore 4 ante e 4 cassetti.

Storage unit with 4 doors and 4 drawers.

167,4	1,032	257,6	46,5	82,2	9VCN08.4501.71B	rovere sbiancato/white oak
167,4	1,032	257,6	46,5	82,2	9VCN08.4501.72B	rovere moka/mocha oak

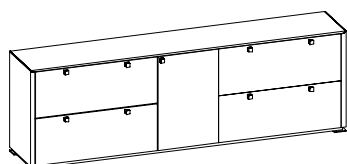

Contenitore 4 portacartelle e 1 anta.

Storage unit with 4 filing drawers and 1 door.

176,7	1,606	257,6	46,5	82,2	9VCN08.4501.71C	rovere sbiancato/white oak
176,7	1,606	257,6	46,5	82,2	9VCN08.4501.72C	rovere moka/mocha oak

CONTENITORI H. 82,2 - P. 46,5 • STORAGE UNITS 82,2 H. - 46,5 W.

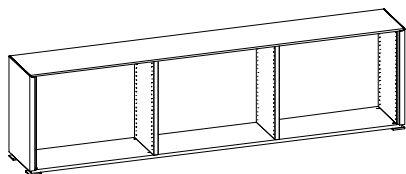

Contenitore aperto con tre vani l. 96,3.
Struttura melaminico finitura alluminio, fianchi di finitura e tops impiallacciati rovere.
Piedini regolabili con piastre in alluminio.
*Open storage unit with three 96,3 w. compartments.
Melamine structure in aluminium colour, sides and tops in oak veneer. Adjustable feet mounted on aluminium plates.*

Per ottenere soluzioni personalizzate
vedi pag. 44

*In order to obtain a personalized
solution, please look at page 44*

128	0,633	307,5	46,5	82,2	9VCN09.4501.71	rovere sbiancato/white oak
128	0,633	307,5	46,5	82,2	9VCN09.4501.72	rovere moka/mocha oak

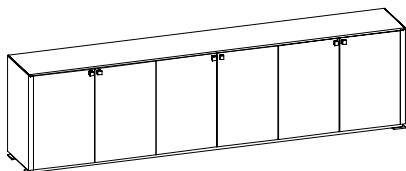

Contenitore con 6 ante.
Storage unit with 6 doors.

187,7	0,885	307,5	46,5	82,2	9VCN09.4501.71A	rovere sbiancato/white oak
187,7	0,885	307,5	46,5	82,2	9VCN09.4501.72A	rovere moka/mocha oak

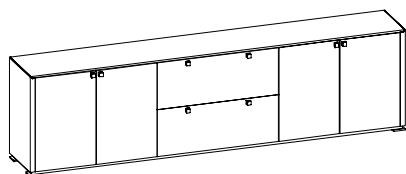

Contenitore 4 ante e 2 portacartelle.
Storage unit with 4 doors and 2 filing drawers.

193,8	1,291	307,5	46,5	82,2	9VCN09.4501.71B	rovere sbiancato/white oak
193,8	1,291	307,5	46,5	82,2	9VCN09.4501.72B	rovere moka/mocha oak

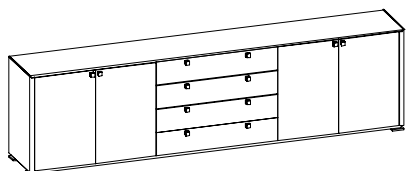

Contenitore 4 ante e 4 cassetti.
Storage unit with 4 doors and 4 drawers.

189,8	1,333	307,5	46,5	82,2	9VCN09.4501.71C	rovere sbiancato/white oak
189,8	1,333	307,5	46,5	82,2	9VCN09.4501.72C	rovere moka/mocha oak

CONTENITORI H. 82,2 - P. 46,5 • STORAGE UNITS 82,2 H. - 46,5 W.

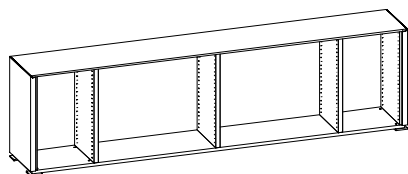

Per ottenere soluzioni personalizzate
vedi pag. 44

In order to obtain a personalized
solution, please look at page 44

Contenitore aperto con due vani l. 46,4 e due vani l. 96,3.

Struttura melaminico finitura alluminio, fianchi di finitura e tops impiallacciati rovere.
Piedini regolabili con piastre in alluminio.

Open storage unit with two 46,4 w. compartments and two 96,3 w. compartments.
Melamine structure in aluminium colour, sides and tops in oak veneer. Adjustable feet
mounted on aluminium plates.

137,3	0,674	307,5	46,5	82,2	9VCN10.4501.71	rovere sbiancato/white oak
137,3	0,674	307,5	46,5	82,2	9VCN10.4501.72	rovere moka/mocha oak

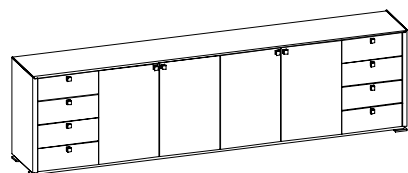

Contenitore 8 cassetti e 4 ante.

Storage unit with 8 drawers and 4 doors.

202,7	1,402	307,5	46,5	82,2	9VCN10.4501.71A	rovere sbiancato/white oak
202,7	1,402	307,5	46,5	82,2	9VCN10.4501.72A	rovere moka/mocha oak

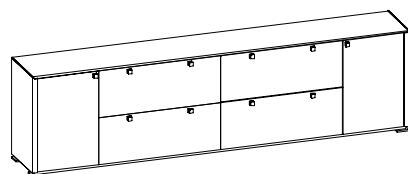

Contenitore 4 portacartelle e 2 ante.

Storage unit with 4 filing drawers and 2 doors.

209,1	1,738	307,5	46,5	82,2	9VCN10.4501.71B	rovere sbiancato/white oak
209,1	1,738	307,5	46,5	82,2	9VCN10.4501.72B	rovere moka/mocha oak

COMPONENTI PER CONTENITORI H. 82,2 • STORAGE UNITS COMPONENTS 82,2 H.



Anta rovere destra (1 ripiano)
Oak door, right (1 shelf)

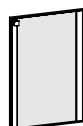

Anta cristallo satinato temperato
destra (1 ripiano)
Tempered frosted glass door, right
(1 shelf)

9,9	0,042	9VFC01.4501.71	rovere sbiancato/white oak	137,00
9,9	0,042	9VFC01.4501.72	rovere moka/mocha oak	137,00

8,7	0,042	9VFC01.0008.80	alluminio/aluminium	
-----	-------	-----------------------	---------------------	--

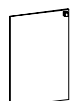

Anta rovere sinistra (1 ripiano)
Oak door, left (1 shelf)

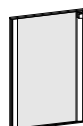

Anta cristallo sinistra (1 ripiano)
Glass door, left (1 shelf)

9,9	0,042	9VFC01.4511.71	rovere sbiancato/white oak	137,00
9,9	0,042	9VFC01.4511.72	rovere moka/mocha oak	137,00

8,7	0,042	9VFC01.0018.80	alluminio/aluminium	
-----	-------	-----------------------	---------------------	--

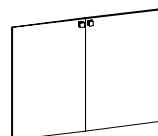

Coppia ante rovere (1 ripiano)
Pair of oak doors (1 shelf)

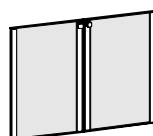

Coppia ante cristallo satinato
temperato (1 ripiano)
Pair of tempered frosted glass doors
(1 shelf)

19,9	0,084	9VFC01.4521.71	rovere sbiancato/white oak	264,00
19,9	0,084	9VFC01.4521.72	rovere moka/mocha oak	264,00

17,5	0,084	9VFC01.0028.80	alluminio/aluminium	
------	-------	-----------------------	---------------------	--

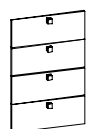

4 cassetti per vano l. 46,4
4 drawers for compartment 46,4 w.

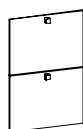

2 portacartelle per vano l. 46,4
2 filing drawers for compartment
46,4 w.

12,8	0,280	9VBX01.4501.71	rovere sbiancato/white oak	556,00
12,8	0,280	9VBX01.4501.72	rovere moka/mocha oak	556,00

13,8	0,258	9VBX05.4501.71	rovere sbiancato/white oak	
------	-------	-----------------------	----------------------------	--

13,8	0,258	9VBX05.4501.72	rovere moka/mocha oak	
------	-------	-----------------------	-----------------------	--

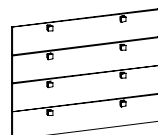

4 cassetti per vano l. 96,3
4 drawers for compartment 96,3 w.

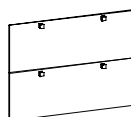

2 portacartelle per vano l. 96,3
(1 ripiano)
2 filing drawers for compartment
96,3 w. (1 shelf)

22,0	0,532	9VBX02.4501.71	rovere sbiancato/white oak	872,00
22,0	0,532	9VBX02.4501.72	rovere moka/mocha oak	872,00

26,0	0,490	9VBX06.4501.71	rovere sbiancato/white oak	
------	-------	-----------------------	----------------------------	--

26,0	0,490	9VBX06.4501.72	rovere moka/mocha oak	
------	-------	-----------------------	-----------------------	--

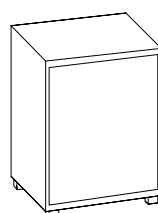

Mini Cool.

LARG.WIDTH PROF.DEPTH ALT.HEIGHT
cm cm cm

€

42,5	37,3	46,5	9QZEA.3080.3	lt. 23
42,5	37,3	58,0	9QZEA.3120.3	lt. 31

CONTENITORI H. 159 - P. 46,5 • STORAGE UNITS 159 H. - 46,5 W.

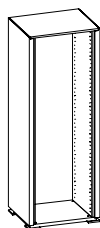

Per ottenere soluzioni personalizzate vedi pag. 56-57

In order to obtain a personalized solution, please look at page 56-57

Contenitore aperto con un vano l. 46,4.

Struttura melaminico finitura alluminio, fianchi di finitura e tops impiallacciati rovere. Piedini regolabili con piastre in alluminio.

Open storage unit with a 46,4 w. compartment.

Melamine structure in aluminium colour, sides and tops in oak veneer. Adjustable feet mounted on aluminium plates.

77,2	0,331	58	46,5	159	9VDN01.4501.71	rovere sbiancato/white oak
77,2	0,331	58	46,5	159	9VDN01.4501.72	rovere moka/mocha oak

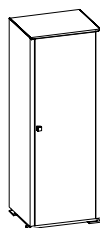

Contenitore destro con 1 anta.
Right storage unit with a door.

101,1	0,426	58	46,5	159	9VDN01.4501.71A	rovere sbiancato/white oak
101,1	0,426	58	46,5	159	9VDN01.4501.72A	rovere moka/mocha oak

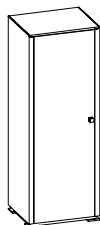

Contenitore sinistro con 1 anta.
Left storage unit with a door.

101,1	0,426	58	46,5	159	9VDN01.4501.71B	rovere sbiancato/white oak
101,1	0,426	58	46,5	159	9VDN01.4501.72B	rovere moka/mocha oak

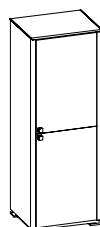

Contenitore destro con 2 ante.
Right storage unit with 2 doors.

101,0	0,427	58	46,5	159	9VDN01.4501.71C	rovere sbiancato/white oak
101,0	0,427	58	46,5	159	9VDN01.4501.72C	rovere moka/mocha oak

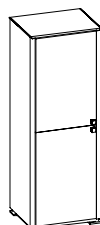

Contenitore sinistro con 2 ante.
Left storage unit with 2 doors.

101,0	0,427	58	46,5	159	9VDN01.4501.71D	rovere sbiancato/white oak
101,0	0,427	58	46,5	159	9VDN01.4501.72D	rovere moka/mocha oak

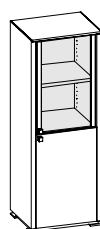

Contenitore destro con 1 anta cristallo satinato temperato e 1 anta rovere.
Right storage unit with 1 temperet frosted glass door and 1 oak door.

99,8	0,427	58	46,5	159	9VDN01.4501.71E	rovere sbiancato/white oak
99,8	0,427	58	46,5	159	9VDN01.4501.72E	rovere moka/mocha oak

CONTENITORI H. 159 - P. 46,5 • STORAGE UNITS 159 H. - 46,5 W.

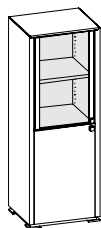

Contenitore sinistro con 1 anta cristallo satinato temperato e 1 anta rovere.
Lefr storage unit with 1 temperet frosted glass door and 1 oak door.

99,8	0,427	58	46,5	159	9VDN01.4501.71F	rovere sbiancato/ <i>white oak</i>
99,8	0,427	58	46,5	159	9VDN01.4501.72F	rovere moka/ <i>mocha oak</i>

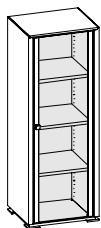

Contenitore destro con 1 anta cristallo satinato temperato.
Right storage unit with a tempered frosted glass door.

98,7	0,426	58	46,5	159	9VDN01.4501.71G	rovere sbiancato/ <i>white oak</i>
98,7	0,426	58	46,5	159	9VDN01.4501.72G	rovere moka/ <i>mocha oak</i>

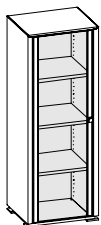

Contenitore sinistro con 1 anta cristallo satinato temperato.
Left storage unit with a tempered frosted glass door.

98,7	0,426	58	46,5	159	9VDN01.4501.71H	rovere sbiancato/ <i>white oak</i>
98,7	0,426	58	46,5	159	9VDN01.4501.72H	rovere moka/ <i>mocha oak</i>

CONTENITORI H. 159 - P. 46,5 • STORAGE UNITS 159 H. - 46,5 W.

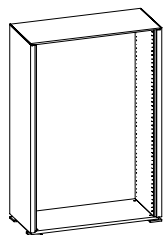

Per ottenere soluzioni personalizzate vedi pag. 57

In order to obtain a personalized solution, please look at page 57

Contenitore aperto con un vano l. 96,3.
Struttura melaminico finitura alluminio, fianchi di finitura e tops impiallacciati rovere.
Piedini regolabili con piastre in alluminio.
*Open storage unit with a 96,3 w. compartment.
Melamine structure in aluminium colour, sides and tops in oak veneer. Adjustable feet mounted on aluminium plates.*

95,7	0,412	107,9	46,5	159	9VDN02.4501.71	rovere sbiancato/white oak
95,7	0,412	107,9	46,5	159	9VDN02.4501.72	rovere moka/mocha oak

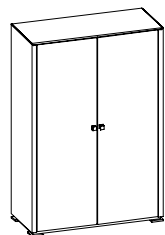

Contenitore con 2 ante.
Storage unit with 2 doors.

143,8	0,602	107,9	46,5	159	9VDN02.4501.71A	rovere sbiancato/white oak
143,8	0,602	107,9	46,5	159	9VDN02.4501.72A	rovere moka/mocha oak

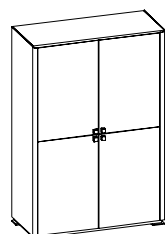

Contenitore con 4 ante.
Storage unit with 4 doors.

143,7	0,604	107,9	46,5	159	9VDN02.4501.71B	rovere sbiancato/white oak
143,7	0,604	107,9	46,5	159	9VDN02.4501.72B	rovere moka/mocha oak

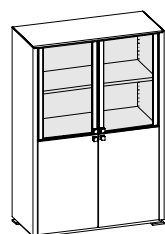

Contenitore con 2 ante cristallo satinato temperato e 2 ante rovere.
Storage unit with 2 tempered frosted glass doors and 2 oak doors.

141,3	0,604	107,9	46,5	159	9VDN02.4501.71C	rovere sbiancato/white oak
141,3	0,604	107,9	46,5	159	9VDN02.4501.72C	rovere moka/mocha oak

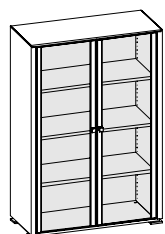

Contenitore con 2 ante cristallo satinato temperato.
Storage unit with 2 tempered frosted glass doors.

139,0	0,602	107,9	46,5	159	9VDN02.4501.71D	rovere sbiancato/white oak
139,0	0,602	107,9	46,5	159	9VDN02.4501.72D	rovere moka/mocha oak

CONTENITORI H. 159 - P. 46,5 • STORAGE UNITS 159 H. - 46,5 W.

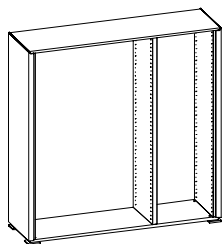

Per ottenere soluzioni personalizzate vedi pag. 56-57
In order to obtain a personalized solution, please look at page 56-57

Contenitore destro aperto con un vano l. 46,4 ed un vano l. 96,3.
Struttura melaminico finitura alluminio, fianchi di finitura e tops impiallacciati rovere.
Piedini regolabili con piastre in alluminio.
Right open storage unit with a 46,4 w. compartment and a 96,3 w. compartment.
Melamine structure in aluminium colour, sides and tops in oak veneer. Adjustable feet mounted on aluminium plates.

133,0	0,516	157,8	46,5	159	9VDN04.4501.71	rovere sbiancato/white oak
133,0	0,516	157,8	46,5	159	9VDN04.4501.72	rovere moka/mocha oak

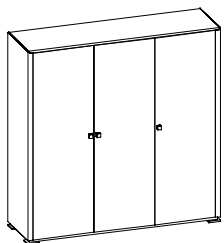

Contenitore con 3 ante.
Storage unit with 3 doors.

205,0	0,801	157,8	46,5	159	9VDN04.4501.71A	rovere sbiancato/white oak
205,0	0,801	157,8	46,5	159	9VDN04.4501.72A	rovere moka/mocha oak

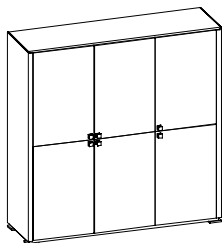

Contenitore con 6 ante.
Storage unit with 6 doors.

204,8	0,804	157,8	46,5	159	9VDN04.4501.71B	rovere sbiancato/white oak
204,8	0,804	157,8	46,5	159	9VDN04.4501.72B	rovere moka/mocha oak

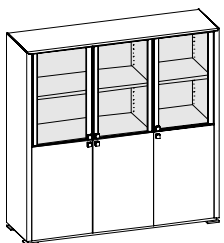

Contenitore con 3 ante cristallo satinato temperato e 3 ante rovere.
Storage unit with 3 tempered frosted glass doors and 3 oak doors.

201,2	0,804	157,8	46,5	159	9VDN04.4501.71C	rovere sbiancato/white oak
201,2	0,804	157,8	46,5	159	9VDN04.4501.72C	rovere moka/mocha oak

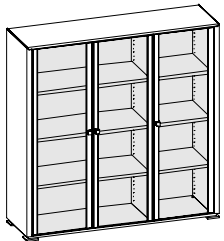

Contenitore con 3 ante cristallo satinato temperato.
Storage unit with 3 tempered frosted glass doors.

197,8	0,801	157,8	46,5	159	9VDN04.4501.71D	rovere sbiancato/white oak
197,8	0,801	157,8	46,5	159	9VDN04.4501.72D	rovere moka/mocha oak

CONTENITORI H. 159 - P. 46,5 • STORAGE UNITS 159 H. - 46,5 W.

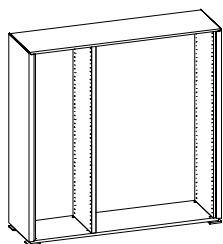

Per ottenere soluzioni personalizzate vedi pag. 56-57
In order to obtain a personalized solution, please look at page 56-57

Contenitore sinistro aperto con un vano l. 46,4 ed un vano l. 96,3.
Struttura melaminico finitura alluminio, fianchi di finitura e tops impiallacciati rovere.
Piedini regolabili con piastre in alluminio.
Left open storage unit with a 46,4 w. compartment and a 96,3 w. compartment.
Melamine structure in aluminium colour, sides and tops in oak veneer. Adjustable feet mounted on aluminium plates.

133,0	0,516	157,8	46,5	159	9VDN04.4511.71	rovere sbiancato/white oak
133,0	0,516	157,8	46,5	159	9VDN04.4511.72	rovere moka/mocha oak

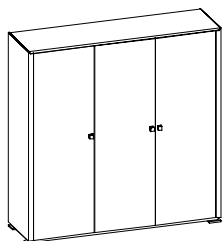

Contenitore con 3 ante.
Storage unit with 3 doors.

205,0	0,801	157,8	46,5	159	9VDN04.4511.71A	rovere sbiancato/white oak
205,0	0,801	157,8	46,5	159	9VDN04.4511.72A	rovere moka/mocha oak

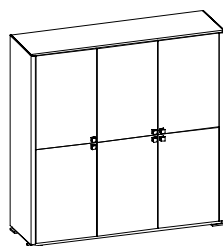

Contenitore con 6 ante.
Storage unit with 6 doors.

204,8	0,804	157,8	46,5	159	9VDN04.4511.71B	rovere sbiancato/white oak
204,8	0,804	157,8	46,5	159	9VDN04.4511.72B	rovere moka/mocha oak

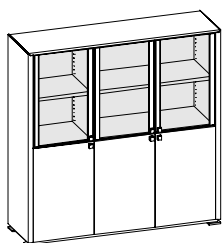

Contenitore con 3 ante cristallo satinato temperato e 3 ante rovere.
Storage unit with 3 tempered frosted glass doors and 3 oak doors.

201,2	0,804	157,8	46,5	159	9VDN04.4511.71C	rovere sbiancato/white oak
201,2	0,804	157,8	46,5	159	9VDN04.4511.72C	rovere moka/mocha oak

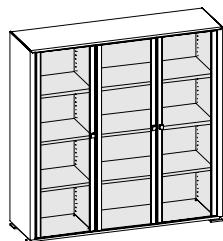

Contenitore con 3 ante cristallo satinato temperato.
Storage unit with 3 tempered frosted glass doors.

197,8	0,801	157,8	46,5	159	9VDN04.4511.71D	rovere sbiancato/white oak
197,8	0,801	157,8	46,5	159	9VDN04.4511.72D	rovere moka/mocha oak

CONTENITORI H. 159 - P. 46,5 • STORAGE UNITS 159 H. - 46,5 W.

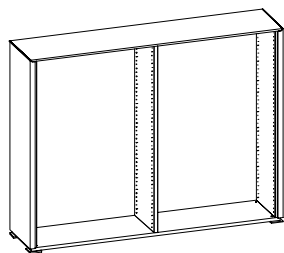

Contenitore aperto con due vani l. 96,3.
Struttura melaminico finitura alluminio, fianchi di finitura e tops impiallacciati rovere.
Piedini regolabili con piastre in alluminio.
*Open storage unit with two 96,3 w. compartments.
Melamine structure in aluminium colour, sides and tops in oak veneer. Adjustable feet mounted on aluminium plates.*

151,8	0,541	207,7	46,5	159	9VDN06.4501.71	rovere sbiancato/white oak
151,8	0,541	207,7	46,5	159	9VDN06.4501.72	rovere moka/mocha oak

Vedi pag. 56-57 - See page 56-57

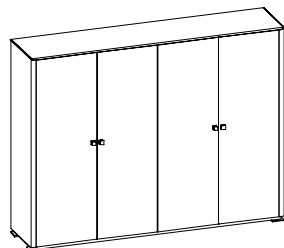

Contenitore con 4 ante.
Storage unit with 4 doors.

248,0	0,921	207,7	46,5	159	9VDN06.4501.71A	rovere sbiancato/white oak
248,0	0,921	207,7	46,5	159	9VDN06.4501.72A	rovere moka/mocha oak

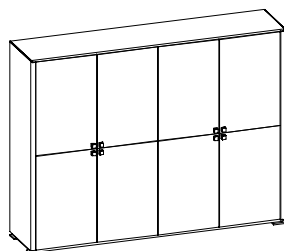

Contenitore con 8 ante.
Storage unit with 8 doors.

247,8	0,925	207,7	46,5	159	9VDN06.4501.71B	rovere sbiancato/white oak
247,8	0,925	207,7	46,5	159	9VDN06.4501.72B	rovere moka/mocha oak

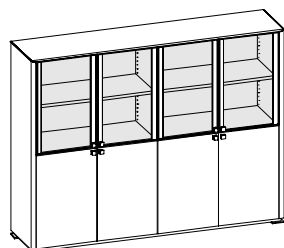

Contenitore con 4 ante cristallo satinato temperato e 4 ante rovere.
Storage unit with 4 tempered frosted glass doors and 4 oak doors.

243,0	0,925	207,7	46,5	159	9VDN06.4501.71C	rovere sbiancato/white oak
243,0	0,925	207,7	46,5	159	9VDN06.4501.72C	rovere moka/mocha oak

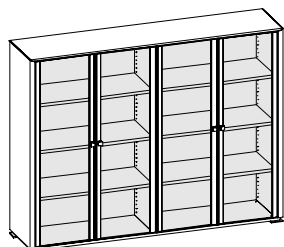

Contenitore con 4 ante cristallo satinato temperato.
Storage unit with 4 tempered frosted glass doors.

238,4	0,921	207,7	46,5	159	9VDN06.4501.71D	rovere sbiancato/white oak
238,4	0,921	207,7	46,5	159	9VDN06.4501.72D	rovere moka/mocha oak

CONTENITORI H. 159 - P. 46,5 • STORAGE UNITS 159 H. - 46,5 W.

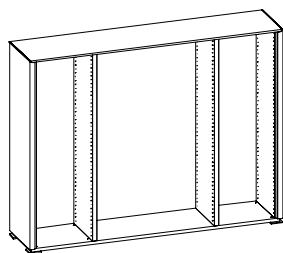

Contenitore aperto con due vani l. 46,4 ed un vano l. 96,3.
Struttura melaminico finitura alluminio, fianchi di finitura e tops impiallacciati rovere.
Piedini regolabili con piastre in alluminio.
*Open storage unit with two 46,4 w. compartments and a 96,3 w. compartment.
Melamine structure in aluminium colour, sides and tops in oak veneer. Adjustable feet mounted on aluminium plates.*

170,5	0,620	207,7	46,5	159	9VDN07.4501.71	rovere sbiancato/white oak
170,5	0,620	207,7	46,5	159	9VDN07.4501.72	rovere moka/mocha oak

Vedi pag. 56-57 - See page 56-57

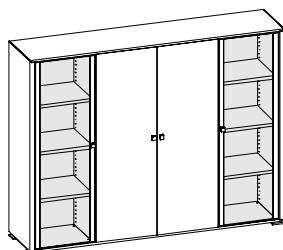

Contenitore con 2 ante cristallo satinato temperato e 2 ante rovere.
Storage unit with 2 tempered frosted glass doors and 2 oak doors.

261,6	1,00	207,7	46,5	159	9VDN07.4501.71A	rovere sbiancato/white oak
261,6	1,00	207,7	46,5	159	9VDN07.4501.72A	rovere moka/mocha oak

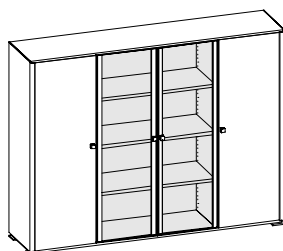

Contenitore con 2 ante cristallo satinato temperato e 2 ante rovere.
Storage unit with 2 tempered frosted glass doors and 2 oak doors.

261,6	1,00	207,7	46,5	159	9VDN07.4501.71B	rovere sbiancato/white oak
261,6	1,00	207,7	46,5	159	9VDN07.4501.72B	rovere moka/mocha oak

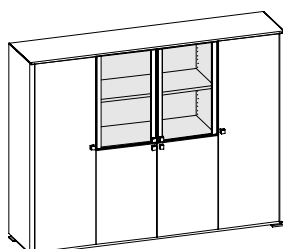

Contenitore con 2 ante cristallo satinato temperato e 4 ante rovere.
Storage unit with 2 tempered frosted glass doors and 4 oak doors.

263,9	1,00	207,7	46,5	159	9VDN07.4501.71C	rovere sbiancato/white oak
263,9	1,00	207,7	46,5	159	9VDN07.4501.72C	rovere moka/mocha oak

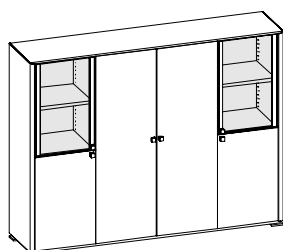

Contenitore con 2 ante cristallo satinato temperato e 4 ante rovere.
Storage unit with 2 tempered frosted glass doors and 4 oak doors.

263,9	1,00	207,7	46,5	159	9VDN07.4501.71D	rovere sbiancato/white oak
263,9	1,00	207,7	46,5	159	9VDN07.4501.72D	rovere moka/mocha oak

CONTENITORI H. 159 - P. 46,5 • STORAGE UNITS 159 H. - 46,5 W.

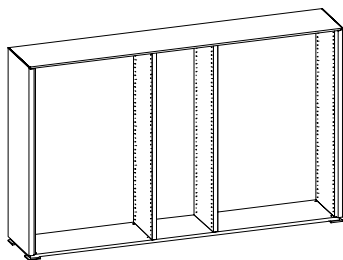

Vedi pag. 56-57 - See page 56-57

Contenitore aperto con un vano l. 46,4 e due vani l. 96,3.
Struttura melaminico finitura alluminio, fianchi di finitura e tops impiallacciati rovere.
Piedini regolabili con piastre in alluminio.
*Open storage unit with a 46,4 w. compartment and two 96,3 w. compartments.
Melamine structure in aluminium colour, sides and tops in oak veneer. Adjustable feet mounted on aluminium plates.*

189,2	0,775	257,6	46,5	159	9VDN08.4501.71	rovere sbiancato/white oak
189,2	0,775	257,6	46,5	159	9VDN08.4501.72	rovere moka/mocha oak

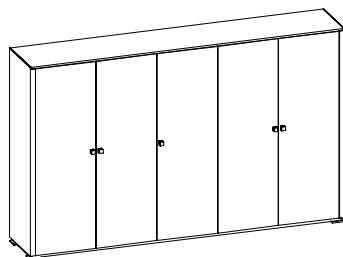

Contenitore con 5 ante.
Storage unit with 5 doors.

309,3	1,25	257,6	46,5	159	9VDN08.4501.71A	rovere sbiancato/white oak
309,3	1,25	257,6	46,5	159	9VDN08.4501.72A	rovere moka/mocha oak

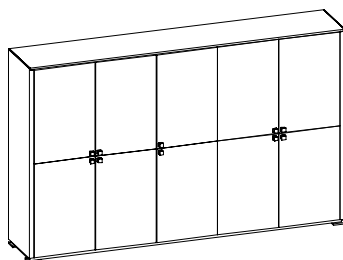

Contenitore con 10 ante.
Storage unit with 10 doors.

309,0	1,25	257,6	46,5	159	9VDN08.4501.71B	rovere sbiancato/white oak
309,0	1,25	257,6	46,5	159	9VDN08.4501.72B	rovere moka/mocha oak

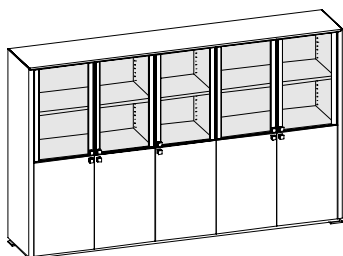

Contenitore con 5 ante cristallo satinato temperato e 5 ante rovere.
Storage unit with 5 tempered frosted glass doors and 5 oak doors.

303,0	1,25	257,6	46,5	159	9VDN08.4501.71C	rovere sbiancato/white oak
303,0	1,25	257,6	46,5	159	9VDN08.4501.72C	rovere moka/mocha oak

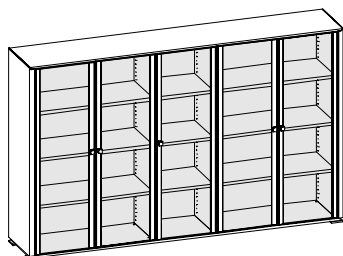

Contenitore con 5 ante cristallo satinato temperato.
Storage unit with 5 tempered frosted glass doors.

297,3	1,25	257,6	46,5	159	9VDN08.4501.71D	rovere sbiancato/white oak
297,3	1,25	257,6	46,5	159	9VDN08.4501.72D	rovere moka/mocha oak

CONTENITORI H. 159 - P. 46,5 • STORAGE UNITS 159 H. - 46,5 W.

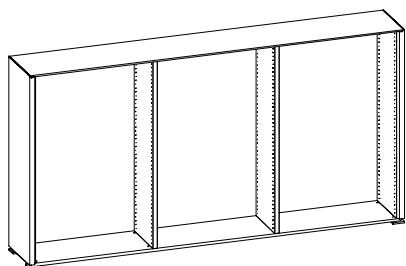

Contenitore aperto con tre vani l. 96,3.
Struttura melaminico finitura alluminio, fianchi di finitura e tops impiallacciati rovere.
Piedini regolabili con piastre in alluminio.
*Open storage unit with three 96,3 w. compartments.
Melamine structure in aluminium colour, sides and tops in oak veneer. Adjustable feet mounted on aluminium plates.*

208,0	0,941	307,5	46,5	159	9VDN09.4501.71	rovere sbiancato/white oak
208,0	0,941	307,5	46,5	159	9VDN09.4501.72	rovere moka/mocha oak

Vedi pag. 57- See page 57

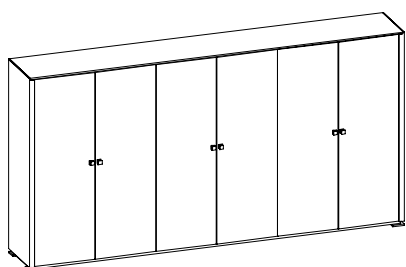

Contenitore con 6 ante.
Storage unit with 6 doors.

352,3	1,511	307,5	46,5	159	9VDN09.4501.71A	rovere sbiancato/white oak
352,3	1,511	307,5	46,5	159	9VDN09.4501.72A	rovere moka/mocha oak

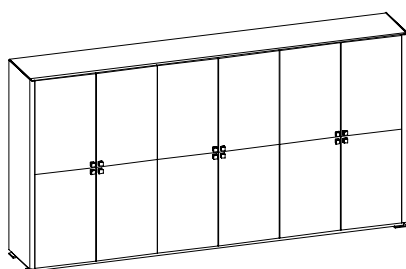

Contenitore con 12 ante.
Storage unit with 12 doors.

352	1,517	307,5	46,5	159	9VDN09.4501.71B	rovere sbiancato/white oak
352	1,517	307,5	46,5	159	9VDN09.4501.72B	rovere moka/mocha oak

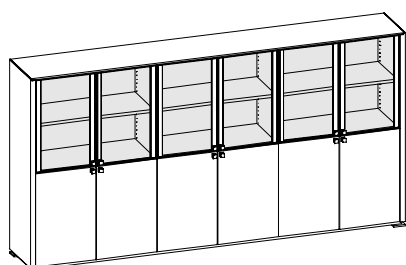

Contenitore con 6 ante cristallo satinato temperato e 6 ante rovere.
Storage unit with 6 tempered frosted glass doors and 6 oak doors.

344,8	1,517	307,5	46,5	159	9VDN09.4501.71C	rovere sbiancato/white oak
344,8	1,517	307,5	46,5	159	9VDN09.4501.72C	rovere moka/mocha oak

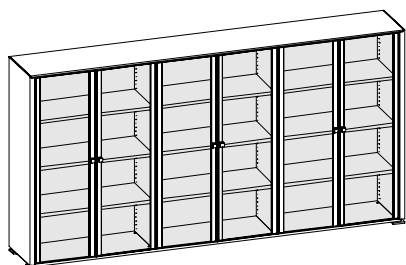

Contenitore con 6 ante cristallo satinato temperato.
Storage unit with 6 tempered frosted glass doors.

337,9	1,511	307,5	46,5	159	9VDN09.4501.71D	rovere sbiancato/white oak
337,9	1,511	307,5	46,5	159	9VDN09.4501.72D	rovere moka/mocha oak

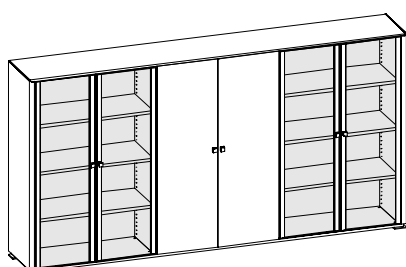

Contenitore con 4 ante cristallo satinato temperato e 2 ante rovere.
Storage unit with 4 tempered frosted glass doors and 2 oak doors.

342,7	1,511	307,5	46,5	159	9VDN09.4501.71E	rovere sbiancato/white oak
342,7	1,511	307,5	46,5	159	9VDN09.4501.72E	rovere moka/mocha oak

CONTENITORI H. 159 - P. 46,5 • STORAGE UNITS 159 H. - 46,5 W.

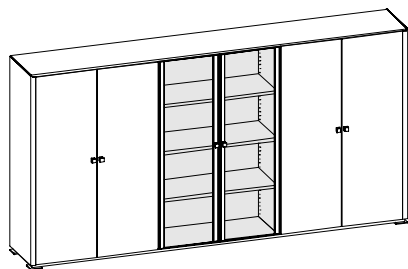

Contenitore con 2 ante cristallo satinato temperato e 4 ante rovere.
Storage unit with 2 tempered frosted glass doors and 4 oak doors.

347,5	1,511	307,5	46,5	159	9VDN09.4501.71F	rovere sbiancato/white oak
347,5	1,511	307,5	46,5	159	9VDN09.4501.72F	rovere moka/mocha oak

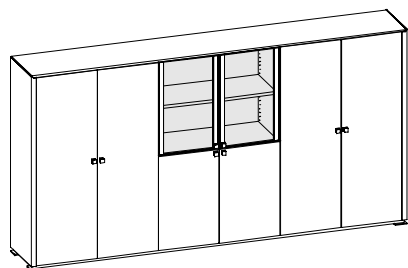

Contenitore con 2 ante cristallo satinato temperato e 6 ante rovere.
Storage unit with 2 tempered frosted glass doors and 6 oak doors.

349,8	1,513	307,5	46,5	159	9VDN09.4501.71G	rovere sbiancato/white oak
349,8	1,513	307,5	46,5	159	9VDN09.4501.72G	rovere moka/mocha oak

CONTENITORI H. 159 - P. 46,5 • STORAGE UNITS 159 H. - 46,5 W.

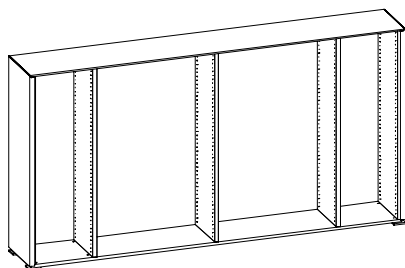

Contenitore aperto con due vani l. 46,4 e due vani l. 96,3.

Struttura melaminico finitura alluminio, fianchi di finitura e tops impiallacciati rovere. Piedini regolabili con piastre in alluminio.

Open storage unit with two 46,4 w. compartments and two 96,3 w. compartments. Melamine structure in aluminium colour, sides and tops in oak veneer. Adjustable feet mounted on aluminium plates.

Vedi pag. 56-57 - See page 56-57

226,7	1,021	307,5	46,5	159	9VDN10.4501.71	rovere sbiancato/white oak
226,7	1,021	307,5	46,5	159	9VDN10.4501.72	rovere moka/mocha oak

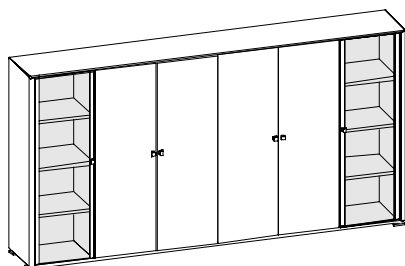

Contenitore con 2 ante cristallo satinato temperato e 4 ante rovere.

Storage unit with 2 tempered frosted glass doors and 4 oak doors.

365,9	1,591	307,5	46,5	159	9VDN10.4501.71A	rovere sbiancato/white oak
365,9	1,591	307,5	46,5	159	9VDN10.4501.72A	rovere moka/mocha oak

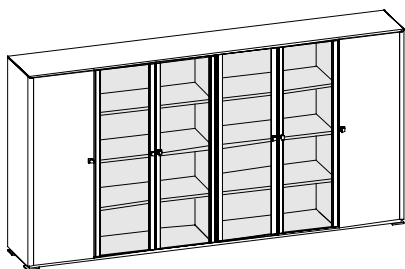

Contenitore con 4 ante cristallo satinato temperato e 2 ante rovere.

Storage unit with 4 tempered frosted glass doors and 2 oak doors.

361,1	1,591	307,5	46,5	159	9VDN10.4501.71B	rovere sbiancato/white oak
361,1	1,591	307,5	46,5	159	9VDN10.4501.72B	rovere moka/mocha oak

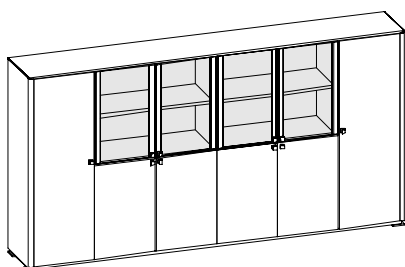

Contenitore con 4 ante cristallo satinato temperato e 6 ante rovere.

Storage unit with 4 tempered frosted glass doors and 6 oak doors.

365,7	1,595	307,5	46,5	159	9VDN10.4501.71C	rovere sbiancato/white oak
365,7	1,595	307,5	46,5	159	9VDN10.4501.72C	rovere moka/mocha oak

COMPONENTI PER CONTENITORI H. 159 • STORAGE UNITS COMPONENTS 159 H.



Anta rovere destra (3 ripiani)
Oak door, right (3 shelves)



Anta rovere sinistra (3 ripiani)
Oak door, left (3 shelves)

23,9	0,095	9VFD01.4501.71	rovere sbiancato/white oak
23,9	0,095	9VFD01.4501.72	rovere moka/mocha oak

23,9	0,095	9VFD01.4511.71	rovere sbiancato/white oak
23,9	0,095	9VFD01.4511.72	rovere moka/mocha oak

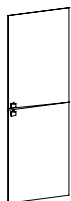

2 ante rovere destre (3 ripiani)
2 oak doors, right (3 shelves)



2 ante rovere sinistre (3 ripiani)
2 oak doors, left (3 shelves)

23,8	0,096	9VFD02.4501.71	rovere sbiancato/white oak
23,8	0,096	9VFD02.4501.72	rovere moka/mocha oak

23,8	0,096	9VFD02.4511.71	rovere sbiancato/white oak
23,8	0,096	9VFD02.4511.72	rovere moka/mocha oak

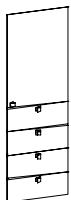

1 anta rovere destra + 4 cassetti
(2 ripiani)
1 oak door, right + 4 drawers
(2 shelves)



1 anta rovere sinistra + 4 cassetti
(2 ripiani)
1 oak door, left + 4 drawers
(2 shelves)

26,7	0,334	9VFD03.4501.71	rovere sbiancato/white oak
26,7	0,334	9VFD03.4501.72	rovere moka/mocha oak

26,7	0,334	9VFD03.4511.71	rovere sbiancato/white oak
26,7	0,334	9VFD03.4511.72	rovere moka/mocha oak

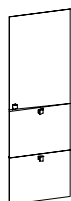

1 anta rovere destra
+ 2 portacartelle (3 ripiani)
1 oak door, right + 2 filing drawers
(3 shelves)



1 anta rovere sinistra
+ 2 portacartelle (3 ripiani)
1 oak door, left + 2 filing drawers
(3 shelves)

27,6	0,312	9VFD04.4501.71	rovere sbiancato/white oak
27,6	0,312	9VFD04.4501.72	rovere moka/mocha oak

27,6	0,312	9VFD04.4511.71	rovere sbiancato/white oak
27,6	0,312	9VFD04.4511.72	rovere moka/mocha oak



1 anta cristallo satinato temperato
destra (3 ripiani)
1 tempered frosted glass door, right
(3 shelves)

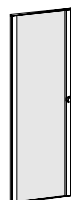

1 anta cristallo satinato temperato
sinistra (3 ripiani)
1 tempered frosted glass door, left
(3 shelves)

21,5	0,095	9VFD01.0008.80	alluminio/aluminium
------	-------	-----------------------	---------------------

21,5	0,095	9VFD02.0019.80	alluminio/aluminium
------	-------	-----------------------	---------------------

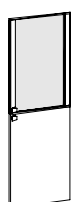

1 anta cristallo satinato temperato
destra + 1 anta rovere destra
(3 ripiani)
1 tempered frosted glass door, right
+ 1 oak door, right (3 shelves)

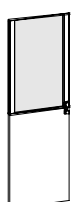

1 anta cristallo satinato temperato
sinistra + 1 anta rovere sinistra
(3 ripiani)
1 tempered frosted glass door, left
+ 1 oak door, left (3 shelves)

22,6	0,096	9VFD02.0009.71	rovere sbiancato/white oak
22,6	0,096	9VFD02.0009.72	rovere moka/mocha oak

22,6	0,096	9VFD02.0019.71	rovere sbiancato/white oak
22,6	0,096	9VFD02.0019.72	rovere moka/mocha oak

COMPONENTI PER CONTENITORI H. 159 • STORAGE UNITS COMPONENTS 159 H.

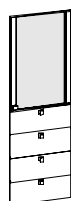

1 anta cristallo satinato temperato
destra + 4 cassetti (2 ripiani)
1 tempered frosted glass door, right
+ 4 drawers (2 shelves)

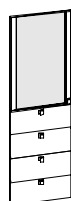

1 anta cristallo satinato temperato
sinistra + 4 cassetti (2 ripiani)
1 tempered frosted glass door, left
+ 4 drawers (2 shelves)

25,5 0,334 **9VFD03.0009.71** rovere sbiancato/white oak

25,5 0,334 **9VFD03.0009.72** rovere moka/mocha oak

25,5 0,334 **9VFD03.0019.71** rovere sbiancato/white oak

25,5 0,334 **9VFD03.0019.72** rovere moka/mocha oak

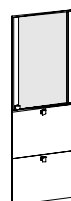

1 anta cristallo satinato temperato
destra + 2 portacartelle (3 ripiani)
1 tempered frosted glass door, right
+ 2 filing drawers (3 shelves)

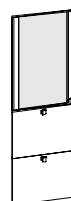

1 anta cristallo satinato temperato
sinistra + 2 portacartelle (3 ripiani)
1 tempered frosted glass door, left
+ 2 filing drawers (3 shelves)

26,4 0,312 **9VFD04.0009.71** rovere sbiancato/white oak

26,4 0,312 **9VFD04.0009.72** rovere moka/mocha oak

26,4 0,312 **9VFD04.0019.71** rovere sbiancato/white oak

26,4 0,312 **9VFD04.0019.72** rovere moka/mocha oak

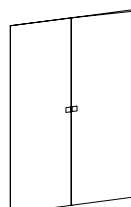

2 ante rovere (3 ripiani)
2 oak doors (3 shelves)

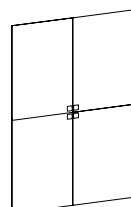

4 ante rovere (3 ripiani)
4 oak doors (3 shelves)

48,1 0,190 **9VFD01.4521.71** rovere sbiancato/white oak

48,1 0,190 **9VFD01.4521.72** rovere moka/mocha oak

48,00 0,192 **9VFD02.4521.71** rovere sbiancato/white oak

48,00 0,192 **9VFD02.4521.72** rovere moka/mocha oak

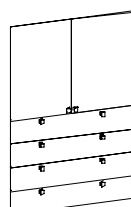

2 ante rovere + 4 cassetti (2 ripiani)
2 oak doors + 4 drawers
(2 shelves)

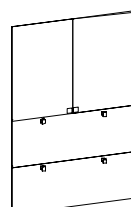

2 ante rovere + 2 portacartelle
(3 ripiani)
2 oak doors + 2 filing drawers
(3 shelves)

50,1 0,640 **9VFD03.4521.71** rovere sbiancato/white oak

50,1 0,640 **9VFD03.4521.72** rovere moka/mocha oak

54,1 0,598 **9VFD04.4521.71** rovere sbiancato/white oak

54,1 0,598 **9VFD04.4521.72** rovere moka/mocha oak

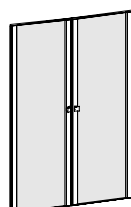

2 ante cristallo satinato temperato
(3 ripiani)
2 tempered frosted glass doors
(3 shelves)

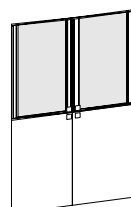

2 ante cristallo satinato temperato
+ 2 ante rovere (3 ripiani)
2 tempered frosted glass doors
+ 2 oak doors (3 shelves)

43,3 0,190 **9VFD01.0028.80** alluminio/aluminium

45,6 0,192 **9VFD02.0029.71** rovere sbiancato/white oak

45,6 0,192 **9VFD02.0029.72** rovere moka/mocha oak

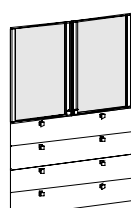

2 ante cristallo satinato temperato
+ 4 cassetti (2 ripiani)
2 tempered frosted glass doors
+ 4 drawers (2 shelves)

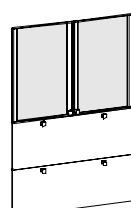

2 ante cristallo satinato temperato
+ 2 portacartelle (3 ripiani)
2 tempered frosted glass doors
+ 2 filing drawers (3 shelves)

47,7 0,640 **9VFD03.0029.71** rovere sbiancato/white oak

47,7 0,640 **9VFD03.0029.72** rovere moka/mocha oak

51,7 0,598 **9VFD04.0029.71** rovere sbiancato/white oak

51,7 0,598 **9VFD04.0029.72** rovere moka/mocha oak

CONTENITORI H. 197,5 - P. 46,5 • STORAGE UNITS 197,5 H. - 46,5 W.

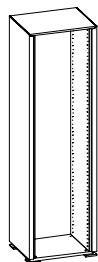

Per ottenere soluzioni personalizzate vedi pag. 69-70

In order to obtain a personalized solution, please look at page 69-70

Contenitore aperto con un vano l. 46,4
Struttura melaminico finitura alluminio, fianchi di finitura e tops impiallacciati rovere.
Piedini regolabili con piastre in alluminio.
*Open storage unit with a 46,4 w. compartment.
Melamine structure in aluminium colour, sides and tops in oak veneer. Adjustable feet mounted on aluminium plates.*

93,8	0,401	58	46,5	197,5	9VEN01.4501.71	rovere sbiancato/white oak
93,8	0,401	58	46,5	197,5	9VEN01.4501.72	rovere moka/mocha oak

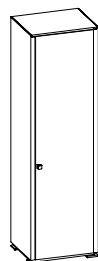

Contenitore destro con 1 anta.
Right storage unit with a door.

124,6	0,522	58	46,5	197,5	9VEN01.4501.71A	rovere sbiancato/white oak
124,6	0,522	58	46,5	197,5	9VEN01.4501.72A	rovere moka/mocha oak

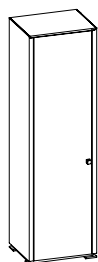

Contenitore sinistro con 1 anta.
Left storage unit with a door.

124,6	0,522	58	46,5	197,5	9VEN01.4501.71B	rovere sbiancato/white oak
124,6	0,522	58	46,5	197,5	9VEN01.4501.72B	rovere moka/mocha oak

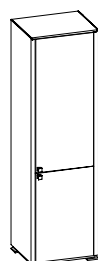

Contenitore destro con 2 ante.
Right storage unit with 2 doors.

124,6	0,523	58	46,5	197,5	9VEN01.4501.71C	rovere sbiancato/white oak
124,6	0,523	58	46,5	197,5	9VEN01.4501.72C	rovere moka/mocha oak

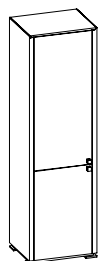

Contenitore sinistro con 2 ante.
Left storage unit with 2 doors.

124,6	0,523	58	46,5	197,5	9VEN01.4501.71D	rovere sbiancato/white oak
124,6	0,523	58	46,5	197,5	9VEN01.4501.72D	rovere moka/mocha oak

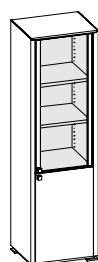

Contenitore destro con 1 anta cristallo satinato temperato e 1 anta rovere.
Right storage unit with 1 tempered frosted glass door and 1 oak door.

122,8	0,523	58	46,5	197,5	9VEN01.4501.71E	rovere sbiancato/white oak
122,8	0,523	58	46,5	197,5	9VEN01.4501.72E	rovere moka/mocha oak

CONTENITORI H. 197,5 - P. 46,5 • STORAGE UNITS 197,5 H. - 46,5 W.

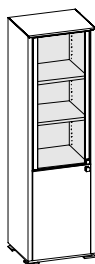

Contenitore sinistro con 1 anta cristallo satinato temperato e 1 anta rovere.
Left storage unit with 1 tempered frosted glass door and 1 oak door.

122,8	0,523	58	46,5	197,5	9VEN01.4501.71F	rovere sbiancato/ <i>white oak</i>
122,8	0,523	58	46,5	197,5	9VEN01.4501.72F	rovere moka/ <i>mocha oak</i>

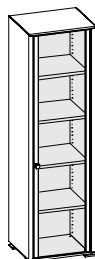

Contenitore destro con 1 anta cristallo satinato temperato.
Right storage unit with 1 tempered frosted glass door.

121,6	0,522	58	46,5	197,5	9VEN01.4501.71G	rovere sbiancato/ <i>white oak</i>
121,6	0,522	58	46,5	197,5	9VEN01.4501.72G	rovere moka/ <i>mocha oak</i>

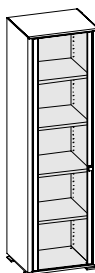

Contenitore sinistro con 1 anta cristallo satinato temperato.
Left storage unit with 1 tempered frosted glass door.

121,6	0,522	58	46,5	197,5	9VEN01.4501.71H	rovere sbiancato/ <i>white oak</i>
121,6	0,522	58	46,5	197,5	9VEN01.4501.72H	rovere moka/ <i>mocha oak</i>

CONTENITORI H. 197,5 - P. 46,5 • STORAGE UNITS 197,5 H. - 46,5 W.

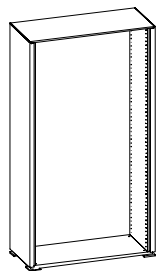

Per ottenere soluzioni personalizzate vedi pag. 70
In order to obtain a personalized solution, please look at page 70

Contenitore aperto con vano l. 96,3.

Struttura melaminico finitura alluminio, fianchi di finitura e tops impiallacciati rovere.
Piedini regolabili con piastre in alluminio.

Open storage unit with a 96,3 w. compartment.

Melamine structure in aluminium colour, sides and tops in oak veneer. Adjustable feet mounted on aluminium plates.

115,3	0,496	107,9	46,5	197,5	9VEN02.4501.71	rovere sbiancato/white oak
115,3	0,496	107,9	46,5	197,5	9VEN02.4501.72	rovere moka/mocha oak

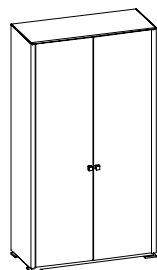

Contenitore con 2 ante.

Storage unit with 2 doors.

177,3	0,738	107,9	46,5	197,5	9VEN02.4501.71A	rovere sbiancato/white oak
177,3	0,738	107,9	46,5	197,5	9VEN02.4501.72A	rovere moka/mocha

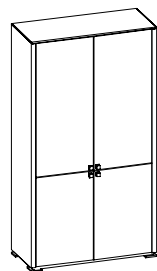

Contenitore con 4 ante.

Storage unit with 4 doors.

177,4	0,740	107,9	46,5	197,5	9VEN02.4501.71B	rovere sbiancato/white oak
177,4	0,740	107,9	46,5	197,5	9VEN02.4501.72B	rovere moka/mocha oak

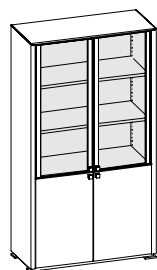

Contenitore con 2 ante cristallo satinato temperato e 2 ante rovere.

Storage unit with 2 tempered frosted glass doors and 2 oak doors.

173,8	0,740	107,9	46,5	197,5	9VEN02.4501.71C	rovere sbiancato/white oak
173,8	0,740	107,9	46,5	197,5	9VEN02.4501.72C	rovere moka/mocha oak

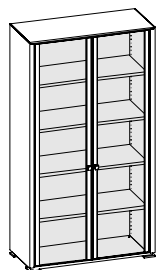

Contenitore con 2 ante cristallo satinato temperato.

Storage unit with 2 tempered frosted glass doors.

171,3	0,738	107,9	46,5	197,5	9VEN02.4501.71D	rovere sbiancato/white oak
171,3	0,738	107,9	46,5	197,5	9VEN02.4501.72D	rovere moka/mocha oak

CONTENITORI H. 197,5 - P. 46,5 • STORAGE UNITS 197,5 H. - 46,5 W.

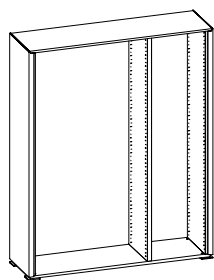

Per ottenere soluzioni personalizzate vedi pag. 69-70
In order to obtain a personalized solution, please look at page 69-70

Contenitore destro aperto con un vano l. 46,4 ed un vano l. 96,3.
Struttura melaminico finitura alluminio, fianchi di finitura e tops impiallacciati rovere.
Piedini regolabili con piastre in alluminio.
Right open storage unit with a 46,4 w. compartment and a 96,3 w. compartment.
Melamine structure in aluminium colour, sides and tops in oak veneer. Adjustable feet mounted on aluminium plates.

160,2	0,619	157,8	46,5	197,5	9VEN04.4501.71	rovere sbiancato/white oak
160,2	0,619	157,8	46,5	197,5	9VEN04.4501.72	rovere moka/mocha oak

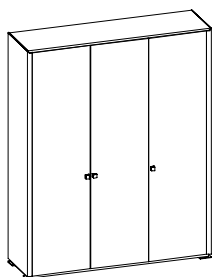

Contenitore con 3 ante.
Storage unit with 3 doors.

253,00	0,982	157,8	46,5	197,5	9VEN04.4501.71A	rovere sbiancato/white oak
253,00	0,982	157,8	46,5	197,5	9VEN04.4501.72A	rovere moka/mocha oak

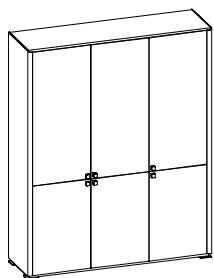

Contenitore con 6 ante.
Storage unit with 6 doors.

253,1	0,985	157,8	46,5	197,5	9VEN04.4501.71B	rovere sbiancato/white oak
253,1	0,985	157,8	46,5	197,5	9VEN04.4501.72B	rovere moka/mocha oak

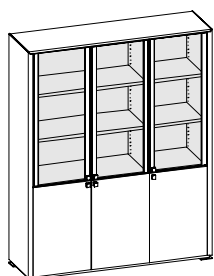

Contenitore con 3 ante cristallo satinato temperato e 3 ante rovere.
Storage unit with 3 tempered frosted glass doors and 3 oak doors.

247,7	0,985	157,8	46,5	197,5	9VEN04.4501.71C	rovere sbiancato/white oak
247,7	0,985	157,8	46,5	197,5	9VEN04.4501.72C	rovere moka/mocha oak

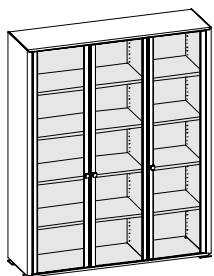

Contenitore con 3 ante cristallo satinato temperato.
Storage unit with 3 tempered frosted glass doors.

244,0	0,982	157,8	46,5	197,5	9VEN04.4501.71D	rovere sbiancato/white oak
244,0	0,982	157,8	46,5	197,5	9VEN04.4501.72D	rovere moka/mocha oak

CONTENITORI H. 197,5 - P. 46,5 • STORAGE UNITS 197,5 H. - 46,5 W.

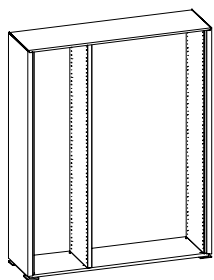

Per ottenere soluzioni personalizzate vedi pag. 69-70
In order to obtain a personalized solution, please look at page 69-70

Contenitore sinistro aperto con un vano l. 46,4 ed un vano l. 96,3.
Struttura melaminico finitura alluminio, fianchi di finitura e tops impiallacciati rovere.
Piedini regolabili con piastre in alluminio.
Left open storage unit with a 46,4 w. compartment and a 96,3 w. compartment.
Melamine structure in aluminium colour, sides and tops in oak veneer. Adjustable feet mounted on aluminium plates.

160,2	0,619	157,8	46,5	197,5	9VEN04.4511.71	rovere sbiancato/white oak
160,2	0,619	157,8	46,5	197,5	9VEN04.4511.72	rovere moka/mocha oak

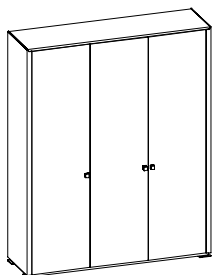

Contenitore con 3 ante.
Storage unit with 3 doors.

253,0	0,982	157,8	46,5	197,5	9VEN04.4511.71A	rovere sbiancato/white oak
253,0	0,982	157,8	46,5	197,5	9VEN04.4511.72A	rovere moka/mocha oak

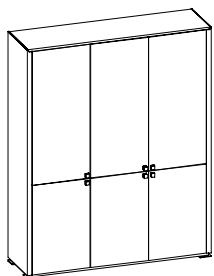

Contenitore con 6 ante.
Storage unit with 6 doors.

253,1	0,985	157,8	46,5	197,5	9VEN04.4511.71B	rovere sbiancato/white oak
253,1	0,985	157,8	46,5	197,5	9VEN04.4511.72B	rovere moka/mocha oak

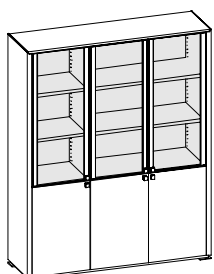

Contenitore con 3 ante cristallo satinato temperato e 3 ante rovere.
Storage unit with 3 tempered frosted glass doors and 3 oak doors.

247,7	0,985	157,8	46,5	197,5	9VEN04.4511.71C	rovere sbiancato/white oak
247,7	0,985	157,8	46,5	197,5	9VEN04.4511.72C	rovere moka/mocha oak

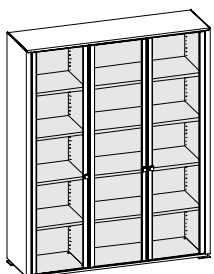

Contenitore con 3 ante cristallo satinato temperato.
Storage unit with 3 tempered frosted glass doors.

244,0	0,982	157,8	46,5	197,5	9VEN04.4511.71D	rovere sbiancato/white oak
244,0	0,982	157,8	46,5	197,5	9VEN04.4511.72D	rovere moka/mocha oak

CONTENITORI H. 197,5 - P. 46,5 • STORAGE UNITS 197,5 H. - 46,5 W.

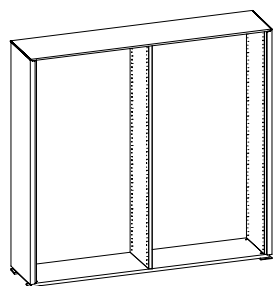

Vedi pag.
70
See page
70

Contenitore aperto con due vani l. 96,3.
Struttura melaminico finitura alluminio, fianchi di finitura e tops impiallacciati rovere.
Piedini regolabili con piastre in alluminio.
*Open storage unit with two 96,3 w. compartments.
Melamine structure in aluminium colour, sides and tops in oak veneer. Adjustable feet mounted on aluminium plates.*

181,6	0,788	207,7	46,5	197,5	9VEN06.4501.71	rovere sbiancato/white oak
181,6	0,788	207,7	46,5	197,5	9VEN06.4501.72	rovere moka/mocha oak

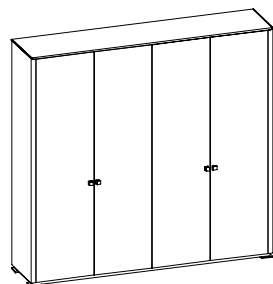

Contenitore con 4 ante.
Storage unit with 4 doors.

305,6	1,272	207,7	46,5	197,5	9VEN06.4501.71A	rovere sbiancato/white oak
305,6	1,272	207,7	46,5	197,5	9VEN06.4501.72A	rovere moka/mocha oak

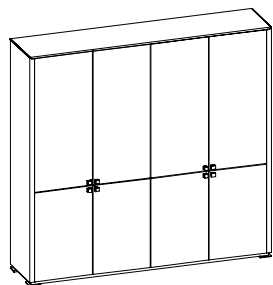

Contenitore con 8 ante.
Storage unit with 8 doors.

305,8	1,276	207,7	46,5	197,5	9VEN06.4501.71B	rovere sbiancato/white oak
305,8	1,276	207,7	46,5	197,5	9VEN06.4501.72B	rovere moka/mocha oak

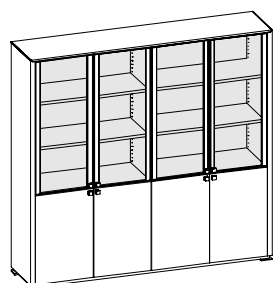

Contenitore con 4 ante cristallo satinato temperato e 4 ante rovere.
Storage unit with 4 tempered frosted glass doors and 4 oak doors.

298,6	1,276	207,7	46,5	197,5	9VEN06.4501.71C	rovere sbiancato/white oak
298,6	1,276	207,7	46,5	197,5	9VEN06.4501.72C	rovere moka/mocha oak

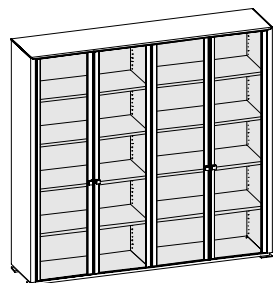

Contenitore con 4 ante cristallo satinato temperato.
Storage unit with 4 tempered frosted glass doors.

293,6	1,272	207,7	46,5	197,5	9VEN06.4501.71D	rovere sbiancato/white oak
293,6	1,272	207,7	46,5	197,5	9VEN06.4501.72D	rovere moka/mocha oak

CONTENITORI H. 197,5 - P. 46,5 • STORAGE UNITS 197,5 H. - 46,5 W.

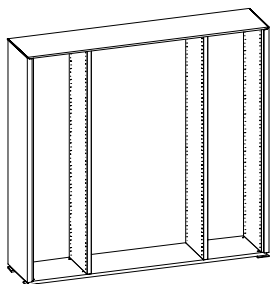

Vedi pag.
69-70
See page
69-70

Contenitore aperto con due vani l. 46,4 ed un vano l. 96,3.
Struttura melaminico finitura alluminio, fianchi di finitura e tops impiallacciati rovere.
Piedini regolabili con piastre in alluminio.
*Open storage unit with two 46,4 w. compartments and a 96,3 w. compartment.
Melamine structure in aluminium colour, sides and tops in oak veneer. Adjustable feet mounted on aluminium plates.*

205,0	0,886	207,7	46,5	197,5	9VEN07.4501.71	rovere sbiancato/white oak
205,0	0,886	207,7	46,5	197,5	9VEN07.4501.72	rovere moka/mocha oak

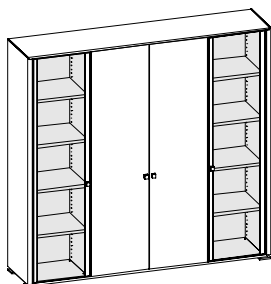

Contenitore con 2 ante cristallo satinato temperato e 2 ante rovere.
Storage unit with 2 tempered frosted glass doors and 2 oak doors.

322,6	1,370	207,7	46,5	197,5	9VEN07.4501.71A	rovere sbiancato/white oak
322,6	1,370	207,7	46,5	197,5	9VEN07.4501.72A	rovere moka/mocha oak

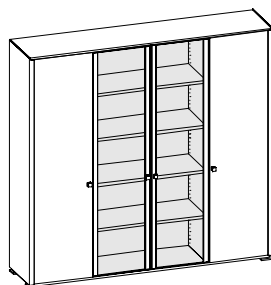

Contenitore con 2 ante cristallo satinato temperato e 2 ante rovere.
Storage unit with 2 tempered frosted glass doors and 2 oak doors.

322,6	1,370	207,7	46,5	197,5	9VEN07.4501.71B	rovere sbiancato/white oak
322,6	1,370	207,7	46,5	197,5	9VEN07.4501.72B	rovere moka/mocha oak

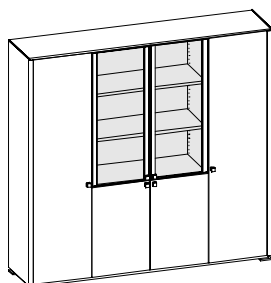

Contenitore con 2 ante cristallo satinato temperato e 4 ante rovere.
Storage unit with 2 tempered frosted glass doors and 4 oak doors.

325,1	1,372	207,7	46,5	197,5	9VEN07.4501.71C	rovere sbiancato/white oak
325,1	1,372	207,7	46,5	197,5	9VEN07.4501.72C	rovere moka/mocha oak

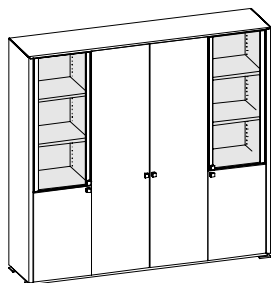

Contenitore con 2 ante cristallo satinato temperato e 4 ante rovere.
Storage unit with 2 tempered frosted glass doors and 4 oak doors.

325,0	1,372	207,7	46,5	197,5	9VEN07.4501.71D	rovere sbiancato/white oak
325,0	1,372	207,7	46,5	197,5	9VEN07.4501.72D	rovere moka/mocha oak

CONTENITORI H. 197,5 - P. 46,5 • STORAGE UNITS 197,5 H. - 46,5 W.

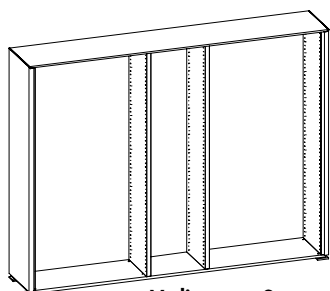

Vedi pag. - See page 69-70

Contenitore aperto con un vano l. 46,4 e due vani l. 96,3.
Struttura melaminico finitura alluminio, fianchi di finitura e tops impiallacciati rovere.
Piedini regolabili con piastre in alluminio.
*Open storage unit with a 46,4 w. compartment and two 96,3 w. compartments.
Melamine structure in aluminium colour, sides and tops in oak veneer. Adjustable feet mounted on aluminium plates.*

226,5	1,041	257,6	46,5	197,5	9VEN08.4501.71	rovere sbiancato/white oak
226,5	1,041	257,6	46,5	197,5	9VEN08.4501.72	rovere moka/mocha oak

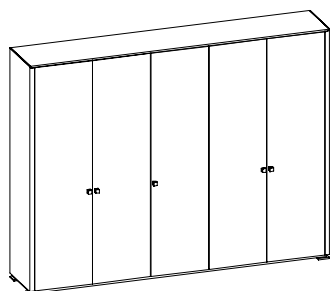

Contenitore con 5 ante.
Storage unit with 5 doors.

381,3	1,646	257,6	46,5	197,5	9VEN08.4501.71A	rovere sbiancato/white oak
381,3	1,646	257,6	46,5	197,5	9VEN08.4501.72A	rovere moka/mocha oak

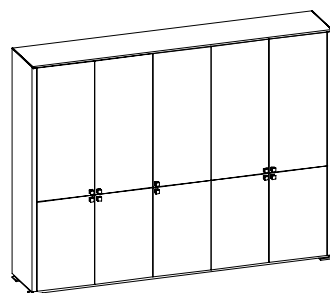

Contenitore con 10 ante.
Storage unit with 10 doors.

381,5	1,651	257,6	46,5	197,5	9VEN08.4501.71B	rovere sbiancato/white oak
381,5	1,651	257,6	46,5	197,5	9VEN08.4501.72B	rovere moka/mocha oak

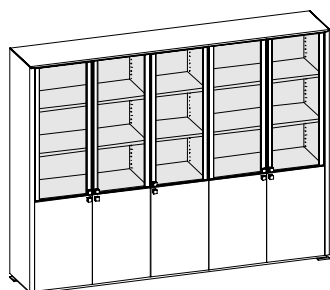

Contenitore con 5 ante cristallo satinato temperato e 5 ante rovere.
Storage unit with 5 tempered frosted glass doors and 5 oak doors.

372,5	1,651	257,6	46,5	197,5	9VEN08.4501.71C	rovere sbiancato/white oak
372,5	1,651	257,6	46,5	197,5	9VEN08.4501.72C	rovere moka/mocha oak

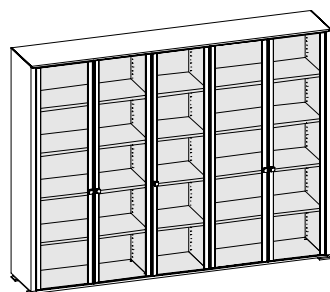

Contenitore con 5 ante cristallo satinato temperato.
Storage unit with 5 tempered frosted glass doors.

366,3	1,646	257,6	46,5	197,5	9VEN08.4501.71D	rovere sbiancato/white oak
366,3	1,646	257,6	46,5	197,5	9VEN08.4501.72D	rovere moka/mocha oak

CONTENITORI H. 197,5 - P. 46,5 • STORAGE UNITS 197,5 H. - 46,5 W.

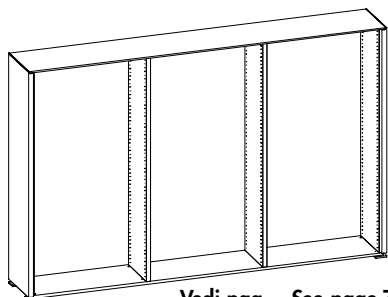

Vedi pag. - See page 70

Contenitore aperto con tre vani l. 96,3.
Struttura melaminico finitura alluminio, fianchi di finitura e tops impiallacciati rovere.
Piedini regolabili con piastre in alluminio.
*Open storage unit with three 96,3 w. compartments.
Melamine structure in aluminium colour, sides and tops in oak veneer. Adjustable feet mounted on aluminium plates.*

248,0	1,235	307,5	46,5	197,5	9VEN09.4501.71	rovere sbiancato/white oak
248,0	1,235	307,5	46,5	197,5	9VEN09.4501.72	rovere moka/mocha oak

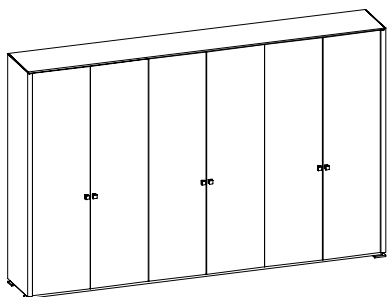

Contenitore con 6 ante.
Storage unit with 6 doors.

434,0	1,961	307,5	46,5	197,5	9VEN09.4501.71A	rovere sbiancato/white oak
434,0	1,961	307,5	46,5	197,5	9VEN09.4501.72A	rovere moka/mocha oak

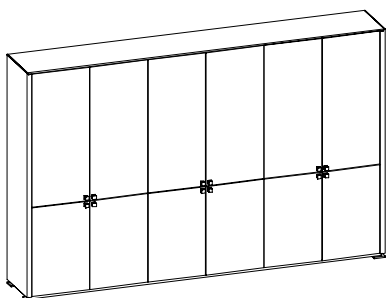

Contenitore con 12 ante.
Storage unit with 12 doors.

434,3	1,967	307,5	46,5	197,5	9VEN09.4501.71B	rovere sbiancato/white oak
434,3	1,967	307,5	46,5	197,5	9VEN09.4501.72B	rovere moka/mocha oak

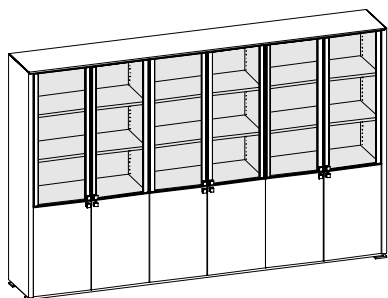

Contenitore con 6 ante cristallo satinato temperato e 6 ante rovere.
Storage unit with 6 tempered frosted glass doors and 6 oak doors.

423,5	1,967	307,5	46,5	197,5	9VEN09.4501.71C	rovere sbiancato/white oak
423,5	1,967	307,5	46,5	197,5	9VEN09.4501.72C	rovere moka/mocha oak

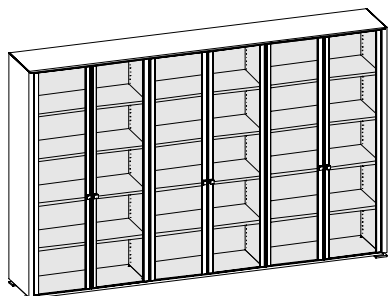

Contenitore con 6 ante cristallo satinato temperato.
Storage unit with 6 tempered frosted glass doors.

416,00	1,961	307,5	46,5	197,5	9VEN09.4501.71D	rovere sbiancato/white oak
416,00	1,961	307,5	46,5	197,5	9VEN09.4501.72D	rovere moka/mocha oak

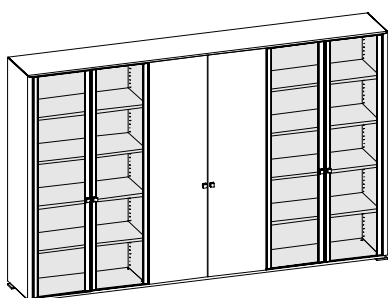

Contenitore con 4 ante cristallo satinato temperato e 2 ante rovere.
Storage unit with 4 tempered frosted glass doors and 2 oak doors.

422,00	1,961	307,5	46,5	197,5	9VEN09.4501.71E	rovere sbiancato/white oak
422,00	1,961	307,5	46,5	197,5	9VEN09.4501.72E	rovere moka/mocha oak

CONTENITORI H. 197,5 - P. 46,5 • STORAGE UNITS 197,5 H. - 46,5 W.

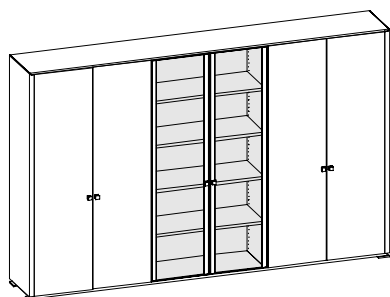

Contenitore con 2 ante cristallo satinato temperato e 4 ante rovere.
Storage unit with 2 tempered frosted glass doors and 4 oak doors.

428,0	1,961	307,5	46,5	197,5	9VEN09.4501.71F	rovere sbiancato/white oak
428,0	1,961	307,5	46,5	197,5	9VEN09.4501.72F	rovere moka/mocha oak

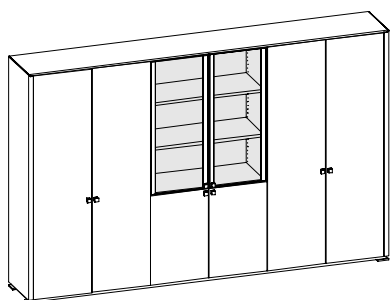

Contenitore con 2 ante cristallo satinato temperato e 6 ante rovere.
Storage unit with 2 tempered frosted glass doors and 6 oak doors.

430,5	1,963	307,5	46,5	197,5	9VEN09.4501.71G	rovere sbiancato/white oak
430,5	1,963	307,5	46,5	197,5	9VEN09.4501.72G	rovere moka/mocha oak

CONTENITORI H. 197,5 - P. 46,5 • STORAGE UNITS 197,5 H. - 46,5 W.

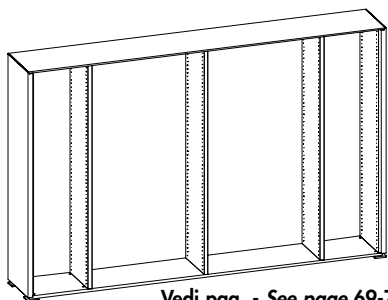

Vedi pag. - See page 69-70

Contenitore aperto con due vani l. 46,4 e due vani l. 96,3.

Struttura melaminico finitura alluminio, fianchi di finitura e tops impiallacciati rovere.

Piedini regolabili con piastre in alluminio.

Open storage unit with two 46,4 w. compartments and two 96,3 w. compartments.

Melamine structure in aluminium colour, sides and tops in oak veneer. Adjustable feet mounted on aluminium plates.

271,3	1,334	307,5	46,5	197,5	9VEN10.4501.71	rovere sbiancato/white oak
271,3	1,334	307,5	46,5	197,5	9VEN10.4501.72	rovere moka/mocha oak

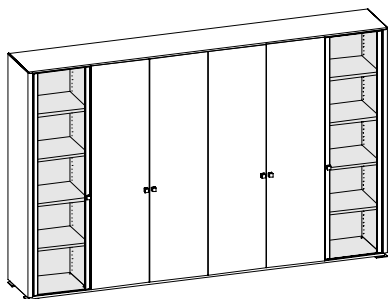

Contenitore con 2 ante cristallo satinato temperato e 4 ante rovere.

Storage unit with 2 tempered frosted glass doors and 4 oak doors.

450,9	2,060	307,5	46,5	197,5	9VEN10.4501.71A	rovere sbiancato/white oak
450,9	2,060	307,5	46,5	197,5	9VEN10.4501.72A	rovere moka/mocha oak

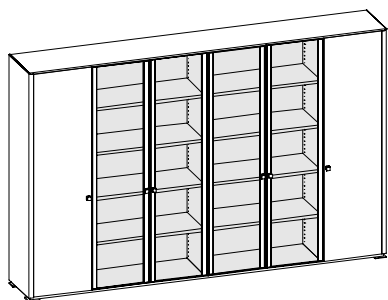

Contenitore con 4 ante cristallo satinato temperato e 2 ante rovere.

Storage unit with 4 tempered frosted glass doors and 2 oak doors.

445,0	2,060	307,5	46,5	197,5	9VEN10.4501.71B	rovere sbiancato/white oak
445,0	2,060	307,5	46,5	197,5	9VEN10.4501.72B	rovere moka/mocha oak

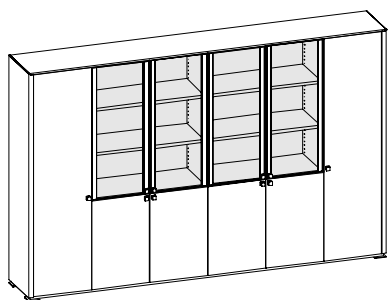

Contenitore con 4 ante cristallo satinato temperato e 6 ante rovere.

Storage unit with 4 tempered frosted glass doors and 6 oak doors.

450,0	2,064	307,5	46,5	197,5	9VEN10.4501.71C	rovere sbiancato/white oak
450,0	2,064	307,5	46,5	197,5	9VEN10.4501.72C	rovere moka/mocha oak

COMPONENTI PER CONTENITORI H. 197,5 • STORAGE UNITS COMPONENTS 159 H.

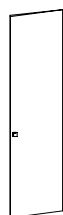

Anta rovere destra (4 ripiani)
Oak door, right (4 shelves)



Anta rovere sinistra (4 ripiani)
Oak door, left (4 shelves)

30,8	0,121	9VFE01.4501.71	rovere sbiancato/white oak
30,8	0,121	9VFE01.4501.72	rovere moka/mocha oak

30,8	0,121	9VFE01.4511.71	rovere sbiancato/white oak
30,8	0,121	9VFE01.4511.72	rovere moka/mocha oak



2 ante rovere destre (4 ripiani)
2 oak doors, right (4 shelves)



2 ante rovere sinistre (4 ripiani)
2 oak doors, left (4 shelves)

30,8	0,122	9VFE02.4501.71	rovere sbiancato/white oak
30,8	0,122	9VFE02.4501.72	rovere moka/mocha oak

30,8	0,122	9VFE02.4511.71	rovere sbiancato/white oak
30,8	0,122	9VFE02.4511.72	rovere moka/mocha oak

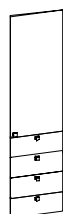

1 anta rovere destra + 4 cassetti
(3 ripiani)
1 oak door, right + 4 drawers
(3 shelves)



1 anta rovere sinistra + 4 cassetti
(3 ripiani)
1 oak door, left + 4 drawers
(3 shelves)

33,7	0,360	9VFE03.4501.71	rovere sbiancato/white oak
33,7	0,360	9VFE03.4501.72	rovere moka/mocha oak

33,7	0,360	9VFE03.4511.71	rovere sbiancato/white oak
33,7	0,360	9VFE03.4511.72	rovere moka/mocha oak



1 anta rovere destra + 2 portacartelle
(4 ripiani)
1 oak door, right + 2 filing drawers
(4 shelves)

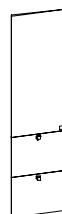

1 anta rovere sinistra + 2 portacartelle
(4 ripiani)
1 oak door, left + 2 filing drawers
(4 shelves)

34,7	0,338	9VFE04.4501.71	rovere sbiancato/white oak
34,7	0,338	9VFE04.4501.72	rovere moka/mocha oak

34,7	0,338	9VFE04.4511.71	rovere sbiancato/white oak
34,7	0,338	9VFE04.4511.72	rovere moka/mocha oak



1 anta cristallo satinato temperato
destra (4 ripiani)
1 tempered frosted glass door, right
(4 shelves)



1 anta cristallo satinato temperato
sinistra (4 ripiani)
1 tempered frosted glass door, left
(4 shelves)

27,8	0,121	9VFE01.0008.80	alluminio/aluminium
------	-------	-----------------------	---------------------

27,8	0,121	9VFE02.0018.80	alluminio/aluminium
------	-------	-----------------------	---------------------



1 anta cristallo satinato temperato
destra + 1 anta rovere destra
(4 ripiani)
1 tempered frosted glass door, right
+ 1 oak door, right (4 shelves)



1 anta cristallo satinato temperato
sinistra + 1 anta rovere sinistra
(4 ripiani)
1 tempered frosted glass door, left
+ 1 oak door, left (4 shelves)

29,0	0,122	9VFE02.0009.71	rovere sbiancato/white oak
29,0	0,122	9VFE02.0009.72	rovere moka/mocha oak

29,0	0,122	9VFE02.0019.71	rovere sbiancato/white oak
29,0	0,122	9VFE02.0019.72	rovere moka/mocha oak

COMPONENTI PER CONTENITORI H. 197,5 • STORAGE UNITS COMPONENTS 159 H.

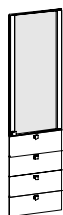

1 anta cristallo satinato temperato
destra + 4 cassetti (3 ripiani)
1 tempered frosted glass door, right
+ 4 drawers (3 shelves)

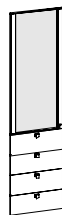

1 anta cristallo satinato temperato
sinistra + 4 cassetti (3 ripiani)
1 tempered frosted glass door, left
+ 4 drawers (3 shelves)

31,9 0,360 **9VFE03.0009.71** rovere sbiancato/white oak

31,9 0,360 **9VFE03.0009.72** rovere moka/mocha oak

31,9 0,36 **9VFE03.0019.71** rovere sbiancato/white oak

31,9 0,36 **9VFE03.0019.72** rovere moka/mocha oak

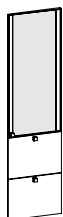

1 anta cristallo satinato temperato
destra + 2 portacartelle (4 ripiani)
1 tempered frosted glass door, right
+ 2 filing drawers (4 shelves)

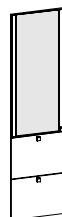

1 anta cristallo satinato temperato
sinistra + 2 portacartelle (4 ripiani)
1 tempered frosted glass door, left
+ 2 filing drawers (4 shelves)

32,9 0,338 **9VFE04.0009.71** rovere sbiancato/white oak

32,9 0,338 **9VFE04.0009.72** rovere moka/mocha oak

32,9 0,338 **9VFE04.0019.71** rovere sbiancato/white oak

32,9 0,338 **9VFE04.0019.72** rovere moka/mocha oak

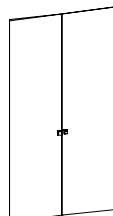

2 ante rovere (4 ripiani)
2 oak doors (4 shelves)

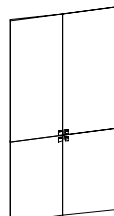

4 ante rovere (4 ripiani)
4 oak doors (4 shelves)

62,0 0,242 **9VFE01.4521.71** rovere sbiancato/white oak

62,0 0,242 **9VFE01.4521.72** rovere moka/mocha oak

62,1 0,244 **9VFE02.4521.71** rovere sbiancato/white oak

62,1 0,244 **9VFE02.4521.72** rovere moka/mocha oak

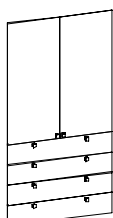

2 ante rovere + 4 cassetti (3 ripiani)
2 oak doors + 4 drawers (3 shelves)

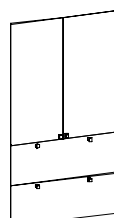

2 ante rovere + 2 portacartelle
(4 ripiani)
2 oak doors + 2 filing drawers
(4 shelves)

64,2 0,692 **9VFE03.4521.71** rovere sbiancato/white oak

64,2 0,692 **9VFE03.4521.72** rovere moka/mocha oak

68,2 0,650 **9VFE04.4521.71** rovere sbiancato/white oak

68,2 0,650 **9VFE04.4521.72** rovere moka/mocha oak

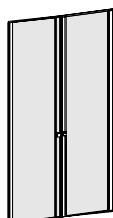

2 ante cristallo satinato temperato
(4 ripiani)
2 tempered frosted glass doors
(4 shelves)

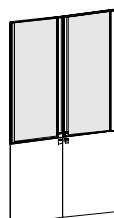

2 ante cristallo satinato temperato +
2 ante rovere (4 ripiani)
2 tempered frosted glass doors
+ 2 oak doors (4 shelves)

56,0 0,242 **9VFE01.0028.80** alluminio/aluminium

58,5 0,244 **9VFE02.0029.71** rovere sbiancato/white oak

58,5 0,244 **9VFE02.0029.72** rovere moka/mocha oak

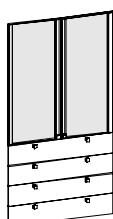

2 ante cristallo satinato temperato
+ 4 cassetti (3 ripiani)
2 tempered frosted glass doors
+ 4 drawers (3 shelves)

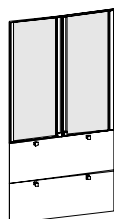

2 ante cristallo satinato temperato
+ 2 portacartelle (4 ripiani)
2 tempered frosted glass doors
+ 2 filing drawers (4 shelves)

60,6 0,692 **9VFE03.0029.71** rovere sbiancato/white oak

60,6 0,692 **9VFE03.0029.72** rovere moka/mocha oak

64,6 0,650 **9VFE04.0029.71** rovere sbiancato/white oak

64,6 0,650 **9VFE04.0029.72** rovere moka/mocha oak

LIBRERIE H. 197,5 - P. 38 • BOOKCASE 197,5 H. - 38 W.

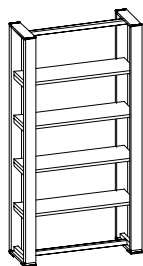

Libreria singola in rovere, travi in alluminio.
Oak single bookcase, aluminium beams.

51,5	0,350	100	38	197,5	9VEN61.4501.71	rovere sbiancato/white oak
51,5	0,350	100	38	197,5	9VEN61.4501.72	rovere moka/mocha oak

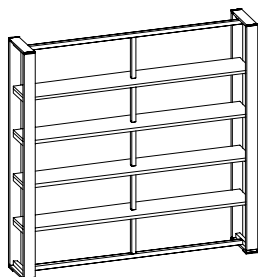

Libreria doppia in rovere, travi in alluminio.
Oak double bookcase, aluminium beams.

81,2	0,440	200	38	197,5	9VEN62.4501.71A	rovere sbiancato/white oak
81,2	0,440	200	38	197,5	9VEN62.4501.72A	rovere moka/mocha oak

COMPONENTI CONTENITORI P. 46,5 • STORAGE UNITS COMPONENTS 46,5 D.



Anta rovere destra
Oak door, right

6,0	0,030	49,6	76,4	2	9VCA01.4501.71	rovere sbiancato/white oak
6,0	0,030	49,6	76,4	2	9VCA01.4501.72	rovere moka/mocha oak



Anta rovere sinistra
Oak door, left

6,0	0,030	49,6	76,4	2	9VCA01.4511.71	rovere sbiancato/white oak
6,0	0,030	49,6	76,4	2	9VCA01.4511.72	rovere moka/mocha oak

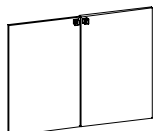

Coppia ante rovere
Pair of oak doors

12,0	0,060	99,5	76,4	2	9VCA01.4521.71	rovere sbiancato/white oak
12,0	0,060	99,5	76,4	2	9VCA01.4521.72	rovere moka/mocha oak



Anta rovere destra
Oak door, right

9,1	0,044	49,6	114,8	2	9VCA02.4501.71	rovere sbiancato/white oak
9,1	0,044	49,6	114,8	2	9VCA02.4501.72	rovere moka/mocha oak

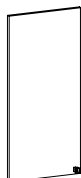

Anta rovere sinistra
Oak door, left

9,1	0,044	49,6	114,8	2	9VCA02.4511.71	rovere sbiancato/white oak
9,1	0,044	49,6	114,8	2	9VCA02.4511.72	rovere moka/mocha oak

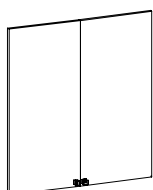

Coppia ante rovere
Pair of oak doors

18,2	0,088	99,5	114,8	2	9VCA02.4521.71	rovere sbiancato/white oak
18,2	0,088	99,5	114,8	2	9VCA02.4521.72	rovere moka/mocha oak

COMPONENTI CONTENITORI P. 46,5 • STORAGE UNITS COMPONENTS 46,5 D.

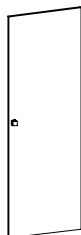

Anta rovere destra
Oak door, right

12,2	0,590	49,6	153,2	2	9VDA01.4501.71	rovere sbiancato/white oak
12,2	0,590	49,6	153,2	2	9VDA01.4501.72	rovere moka/mocha oak

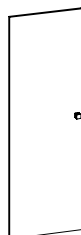

Anta rovere sinistra
Oak door, left

12,2	0,590	49,6	153,2	2	9VDA01.4511.71	rovere sbiancato/white oak
12,2	0,590	49,6	153,2	2	9VDA01.4511.72	rovere moka/mocha oak

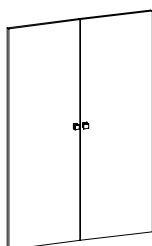

Coppia ante rovere
Pair of oak doors

24,4	0,118	99,5	153,2	2	9VDA01.4521.71	rovere sbiancato/white oak
24,4	0,118	99,5	153,2	2	9VDA01.4521.72	rovere moka/mocha oak

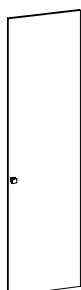

Anta rovere destra
Oak door, right

15,2	0,073	49,6	191,6	2	9VEA01.4501.71	rovere sbiancato/white oak
15,2	0,073	49,6	191,6	2	9VEA01.4501.72	rovere moka/mocha oak



Anta rovere sinistra
Oak door, left

15,2	0,073	49,6	191,6	2	9VEA01.4511.71	rovere sbiancato/white oak
15,2	0,073	49,6	191,6	2	9VEA01.4511.72	rovere moka/mocha oak

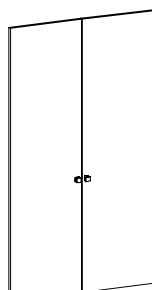

Coppia ante rovere
Pair of oak doors

30,4	0,146	99,5	191,6	2	9VEA01.4521.71	rovere sbiancato/white oak
30,4	0,146	99,5	191,6	2	9VEA01.4521.72	rovere moka/mocha oak

COMPONENTI CONTENITORI P. 46,5 • STORAGE UNITS COMPONENTS 46,5 D.

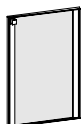

Anta cristallo satinato temperato destra
Tempered frosted glass door, right

4,8	0,030	49,6	76,4	2	9VCA01.0008.80	alluminio/aluminium
-----	-------	------	------	---	-----------------------	---------------------

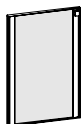

Anta cristallo satinato temperato sinistra
Tempered frosted glass door, left

4,8	0,030	49,6	76,4	2	9VCA01.0018.80	alluminio/aluminium
-----	-------	------	------	---	-----------------------	---------------------

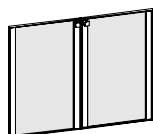

Coppia ante cristallo satinato temperato
Pair of tempered frosted glass doors

9,6	0,060	99,5	76,4	2	9VCA01.0028.80	alluminio/aluminium
-----	-------	------	------	---	-----------------------	---------------------

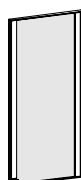

Anta cristallo satinato temperato destra
Tempered frosted glass door, right

7,3	0,044	49,6	114,8	2	9VCA02.0008.80	alluminio/aluminium
-----	-------	------	-------	---	-----------------------	---------------------

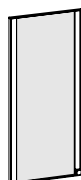

Anta cristallo satinato temperato sinistra
Tempered frosted glass door, left

7,3	0,044	49,6	114,8	2	9VCA02.0018.80	alluminio/aluminium
-----	-------	------	-------	---	-----------------------	---------------------

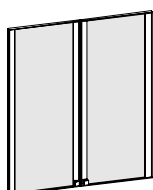

Coppia ante cristallo satinato temperato
Pair of tempered frosted glass doors

14,6	0,088	99,5	114,8	2	9VCA02.0028.80	alluminio/aluminium
------	-------	------	-------	---	-----------------------	---------------------

COMPONENTI CONTENITORI P. 46,5 • STORAGE UNITS COMPONENTS 46,5 D.

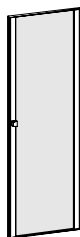

Anta cristallo satinato temperato destra
Tempered frosted glass door, right

9,8	0,059	49,6	153,2	2	9VDA01.0008.80	alluminio/aluminium
-----	-------	------	-------	---	-----------------------	---------------------

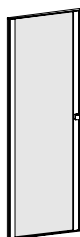

Anta cristallo satinato temperato sinistra
Tempered frosted glass door, left

9,8	0,059	49,6	153,2	2	9VDA01.0018.80	alluminio/aluminium
-----	-------	------	-------	---	-----------------------	---------------------

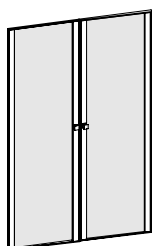

Coppia ante cristallo satinato temperato
Pair of tempered frosted glass doors

19,6	0,118	99,5	153,2	2	9VDA01.0028.80	alluminio/aluminium
------	-------	------	-------	---	-----------------------	---------------------

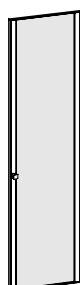

Anta cristallo satinato temperato destra
Tempered frosted glass door, right

12,2	0,073	49,6	191,6	2	9VEA01.0008.80	alluminio/aluminium
------	-------	------	-------	---	-----------------------	---------------------

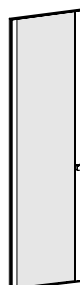

Anta cristallo satinato temperato sinistra
Tempered frosted glass door, left

12,2	0,073	49,6	191,6	2	9VEA01.0018.80	alluminio/aluminium
------	-------	------	-------	---	-----------------------	---------------------

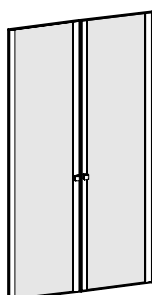

Coppia ante cristallo satinato temperato
Pair of tempered frosted glass doors

24,4	0,146	99,5	191,6	2	9VEA01.0028.80	alluminio/aluminium
------	-------	------	-------	---	-----------------------	---------------------

COMPONENTI CONTENITORI P. 46,5 • STORAGE UNITS COMPONENTS 46,5 D.

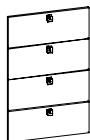

4 cassetti per vano l. 46,4
4 drawers for compartment 46,4 w.

12,8	0,280	49,6	76,4	2	9VBX01.4501.71	rovere sbiancato/white oak
12,8	0,280	49,6	76,4	2	9VBX01.4501.72	rovere moka/mocha oak

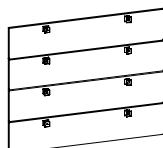

4 cassetti per vano l. 96,3
4 drawers for compartment 96,3 w.

22,0	0,532	99,5	76,4	2	9VBX02.4501.71	rovere sbiancato/white oak
22,0	0,532	99,5	76,4	2	9VBX02.4501.72	rovere moka/mocha oak

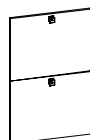

2 portacartelle per vano l. 46,4
2 filing drawers for compartment 46,4 w.

9,8	0,246	49,6	76,4	2	9VBX05.4501.71	rovere sbiancato/white oak
9,8	0,246	49,6	76,4	2	9VBX05.4501.72	rovere moka/mocha oak

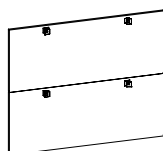

2 portacartelle per vano l. 96,3
2 filing drawers for compartment 96,3 w.

17,8	0,466	99,5	76,4	2	9VBX06.4501.71	rovere sbiancato/white oak
17,8	0,466	99,5	76,4	2	9VBX06.4501.72	rovere moka/mocha oak



1 cassetto per vano l. 46,4
1 drawer for compartment 46,4 w.

3,2	0,070	49,6	19	18,8	9VBX01.4502.71	rovere sbiancato/white oak
3,2	0,070	49,6	19	18,8	9VBX01.4502.72	rovere moka/mocha oak

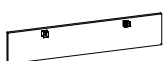

1 cassetto per vano l. 96,3
1 drawer for compartment 96,3 w.

5,5	0,133	99,5	19	18,8	9VBX02.4502.71	rovere sbiancato/white oak
5,5	0,133	99,5	19	18,8	9VBX02.4502.72	rovere moka/mocha oak

COMPONENTI CONTENITORI P. 46,5 • STORAGE UNITS COMPONENTS 46,5 D.



1 portacartelle per vano l. 46,4
1 filing drawer for compartment 46,4 w.

4,9	0,123	49,6	38	2	9VBX05.4502.71	rovere sbiancato/white oak
4,9	0,123	49,6	38	2	9VBX05.4502.72	rovere moka/mocha oak

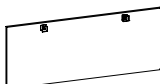

1 portacartelle per vano l. 96,3
1 filing drawer for compartment 96,3 w.

8,9	0,233	99,5	38	2	9VBX06.4502.71	rovere sbiancato/white oak
8,9	0,233	99,5	38	2	9VBX06.4502.72	rovere moka/mocha oak

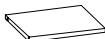

Ripiano interno per vano l. 46,4
Internal shelf for compartment 46,4 w.

3,9	0,012	46,4	41	2,5	9VCR01.4801.80	mel. alluminio/mel. aluminium
-----	-------	------	----	-----	-----------------------	-------------------------------



Ripiano interno per vano l. 96,3
Internal shelf for compartment 96,3 w.

7,9	0,024	96,3	41	2,5	9VCR02.4801.80	mel. alluminio/mel. aluminium
-----	-------	------	----	-----	-----------------------	-------------------------------



Ripiano strutturale per vano l. 46,4
Structural shelf for compartment 46,4 w.

4,0	0,012	46,4	42,5	2,5	9VCR11.4801.80	mel. alluminio/mel. aluminium
-----	-------	------	------	-----	-----------------------	-------------------------------



Ripiano strutturale per vano l. 96,3
Structural shelf for compartment 96,3 w.

8,2	0,024	96,3	42,5	2,5	9VCR12.4801.80	mel. alluminio/mel. aluminium
-----	-------	------	------	-----	-----------------------	-------------------------------

SERRATURE • LOCKS



Serratura per contenitori bassi e medi.
Lock for low and medium size storage units.

9VS210.0202.03 *nicel/nichel*

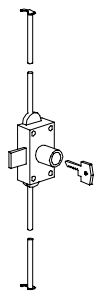

Serratura per contenitori alti.
Lock for tall storage units.

9VS330.0172.03 *nicel/nichel*

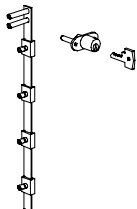

Serratura per contenitori bassi a 4 cassetti.
Lock for low storage units with 4 drawers.

9VS231.1172.03 *nicel/nichel*

DESCRIZIONE TECNICA

SCRIVANIE E TAVOLI RIUNIONE

Piani per scrivanie, tavoli riunione e allunghi costruiti con pannelli in agglomerato ligneo di pioppo (leggero) sp. mm. 40, placcati a caldo con impiallacciatura di "rovere rigato americano"; bordi dello stesso legno di spessore 3 mm. arrotondati. Tutti i piani per tavoli e scrivanie con sostegno "a gamba" hanno di serie il profilo in alluminio inserito nello spessore. Verniciatura in linea con vernici acriliche antingiallenti, in due finiture: rovere "sbiancato" e rovere "tinto moka"; essiccazione in forno a temperatura controllata.

Versioni con piani in cristallo satinato e temperato di spessore mm. 15 con angoli smussati.

Sostegni realizzati in due versioni :

-a quattro gambe con struttura interna portante in alluminio rivestito per metà da fianchetti in legno e metà con profilo in estruso di alluminio millerighe agganciato a "scatto". Possibilità di passaggio cavi all'interno del sostegno.

-con fianchi in legno assemblati a "telaio" mediante l'inserimento di un profilo in alluminio di spessore 4 mm. Rinforzi orizzontali con profilati di alluminio da mm. 45x47. Entrambi i tipi di sostegni hanno le stesse finiture dei piani e alla base delle piastre quadrate in alluminio anodizzato con piedini regolabili.

Travi sottopiano realizzate con profilato in alluminio da mm. 45x47. Collegamento delle travi al piano tramite viti UNI M6x15 a testa bombata. Tutti i particolari di alluminio sono anodizzati con trattamento di ossidatura.

CASSETTIERE (con serratura di serie)

Struttura della cassettera costruita con pannelli in agglomerato ligneo di pioppo (leggero), placcati a caldo con tranciato di "rovere rigato americano"; bordi dello stesso legno di spessore 1,5 mm. I fianchi (sp.40 mm.) sono assemblati con il top superiore (sp. 15 mm.) mediante l'inserimento di un profilo in alluminio di spessore 4 mm. Verniciatura in linea con vernici acriliche antingiallenti, in due finiture: rovere "sbiancato" e rovere "tinto moka"; essiccazione in forno a temperatura controllata.

Schienale in rovere.

Versione "portante" con piedini regolabili montati su piastre quadrate in alluminio anodizzato; versione "con ruote" piroettanti diam. 80 a doppio battistrada anti-affondamento su moquettes, colore grigio alluminio.

Cassetti completamente in alluminio anodizzato argento, attrezzabili anche con portacartelle. Cassettino portacancelleria provvisto anche di un separatore in legno.

Guide "quadro" in acciaio con scorrimento mediante sfere di precisione; chiusura automatica negli ultimi 60 mm. e blocco in apertura per scongiurare cadute accidentali. Nel caso di portacartelle, le guide sono ad estrazione totale.

Serratura con asta in acciaio e fermi di battuta a chiusura simultanea dei cassetti direttamente sulle spondine; chiave cromata in doppio esemplare.

Le **maniglie** sono in alluminio anodizzato argento, di forma quadrata.

PORTA-COMPUTER E PORTA-MONITOR

Struttura costruita con profilato in alluminio anodizzato mm. 25x25, collegato da apposite giunzioni.

Piani e schienale con pannelli in agglomerato ligneo di pioppo (leggero) sp. 20 mm., placcati a caldo con tranciato di "rovere rigato americano"; bordi dello stesso legno di spessore 1,5 mm. Verniciatura in linea con vernici acriliche antingiallenti, in due finiture: rovere "sbiancato" e rovere "tinto moka"; essiccazione in forno a temperatura controllata.

Schermo frontale, in vetro temperato satinato spessore 8 mm., ancorato con distanziali alla struttura; è munito di un'asola che favorisce la presa per lo spostamento.

CONTENITORI

Struttura dei contenitori costruita con pannelli in agglomerato ligneo di pioppo (leggero), placcati a caldo con tranciato di "rovere rigato americano"; bordi dello stesso legno di spessore 1,5 mm. I fianchi

(sp.40 mm.) sono assemblati con il top superiore (sp. 15 mm.) mediante l'inserimento di un profilo in alluminio di spessore 4 mm. Verniciatura in linea con vernici acriliche antingiallenti, in due finiture: rovere "sbiancato" e rovere "tinto moka"; essiccazione in forno a temperatura controllata.

Gli interni sono realizzati in nobilitato melaminico colore grigio alluminio.

Piedini regolabili montati su piastre quadrate in alluminio anodizzato.

Ante in legno costruite con pannelli in agglomerato ligneo di pioppo (leggero) sp. 20 mm., placcate a caldo con tranciato di "rovere rigato americano"; bordi dello stesso legno di spessore 1,5 mm. Serratura a richiesta sulle ante legno.

Ante in cristallo costruite con telaio in alluminio anodizzato e vetro temperato satinato.

Tutti i contenitori possono essere realizzati con cassetti e portacartelle esterni, costruiti come quelli delle cassettiere.

Le **maniglie** sono in alluminio anodizzato di forma quadrata.

CONTENITORI DI SERVIZIO (con serratura di serie)

Struttura dei contenitori di servizio costruiti con pannelli in agglomerato ligneo di pioppo (leggero), placcati a caldo con tranciato di "rovere rigato americano"; bordi dello stesso legno di spessore 1,5 mm. I fianchi (sp.40 mm.) sono assemblati con il top superiore (sp. 15 mm.) mediante l'inserimento di un profilo in alluminio di spessore 4 mm. Verniciatura in linea con vernici acriliche antingiallenti, in due finiture: rovere "sbiancato" e rovere "tinto moka"; essiccazione in forno a temperatura controllata.

Schienale in rovere.

Piedini regolabili montati su piastre quadrate in alluminio anodizzato.

Gli interni sono realizzati in nobilitato melaminico colore grigio alluminio.

Ante in legno costruite con pannelli in agglomerato ligneo di pioppo (leggero), placcate a caldo con tranciato di "rovere rigato americano"; bordi dello stesso legno di spessore 1,5 mm.

Cassetti completamente in alluminio anodizzato argento, attrezzabili anche con portacartelle. Cassettino portacancelleria provvisto anche di un separatore in legno.

Guide "quadro" in acciaio con scorrimento mediante sfere di precisione; chiusura automatica negli ultimi 60 mm. e blocco in apertura per scongiurare cadute accidentali. Nel caso di portacartelle, le guide sono ad estrazione totale.

Serratura con asta in acciaio e fermi di battuta a chiusura simultanea dei cassetti direttamente sulle spondine; chiave cromata in doppio esemplare.

Le **maniglie** sono in alluminio anodizzato argento, di forma quadrata.

LIBRERIE A GIORNO

Struttura composta da profilati di alluminio anodizzato mm.35x35 e fianchi in legno realizzati a "telaio" placcati a caldo con tranciato di "rovere rigato americano"; bordi dello stesso legno di spessore 1,5 mm.

I fianchi sono assemblati mediante l'inserimento di un profilo in alluminio di spessore 4 mm. Verniciatura in linea con vernici acriliche antingiallenti, in due finiture: rovere "sbiancato" e rovere "tinto moka"; essiccazione in forno a temperatura controllata.

Ripiani costruiti con pannelli in agglomerato ligneo di pioppo (leggero) sp. mm. 25, placcati a caldo con tranciato di "rovere rigato americano"; bordi dello stesso legno di spessore 1,5 mm. Verniciatura come sopra.

Piedini regolabili montati su piastre quadrate in alluminio anodizzato.

DESKS AND CONFERENCE TABLES

Surfaces for desks, conference tables and extensions made of 40 mm-thick (lightweight) poplar wood particleboard panels, hot-laminated with "American oak" fine cut veneer; 3 mm-thick rounded borders of matching wood.

All tops for desks and tables with legs include an aluminium profile in the edge.

On-line painting with anti-yellowing paints; two finishes are available: white and mocha finish oak; controlled-temperature drying in furnace.

Versions with 15 mm-thick satin and tempered glass surfaces and bevelled corners.

Two support versions:

- four legs with aluminium internal carrying structure; half internal structure is clad with wooden panels and the remaining half with a "snap-on" reeded aluminium extruded profile. The cables can be routed inside the support.

- quad legs with of a 4 mm aluminium profile. 45-47 mm aluminium profile horizontal reinforcement. Both support types have the same surface finishes and anodised aluminium square base plates with adjustable feet.

Undermounted beams made of 45x47 mm aluminium profiles.

The **beams** are fastened to the surface by UNI M6x15 crowned-head screws.

All the aluminium parts are oxidised and anodised.

DRAWER PEDESTALS (with lock):

Drawer pedestal **structure** made of (lightweight) poplar wood particle board panels, hot-laminated with "American oak" fine cut veneer; 1.5 mm-thick rounded borders of matching wood. The side panels (thickness: 40 mm) are fastened to the top surface (thickness 15 mm) by means of a 4 mm-thick aluminium profile. On-line painting with anti-yellowing paints; two finishes are available: white and mocha finish oak; controlled-temperature drying in furnace.

Back finishing panel.

"Load carrying" with adjustable feet mounted on anodised aluminium square plates; 80 mm. diam. castors, dual wheel, for easy gliding action, colour: aluminium grey.

Drawers made of silver anodised aluminium, designed to accommodate filing drawers. Stationery tray with a wooden spacer.

"Quadro" steel **guides** sliding by means of precision spheres; automatic closing in the last 60 mm and opening lock. Fully extendable guides when filing drawers are present.

Lock with steel bar and stops for anti tilt mechanism; chromium-plated double key.

Square anodised aluminium **handles**.

PC-TROLLEYS AND MONITOR STANDS

Structure made of anodised aluminium profile, mm 25x25, connected by special couplings.

Surfaces and back panel made of (lightweight) poplar wood particleboard, thickness: 20 mm, hot-laminated with "American oak" veneer; 1.5 mm-thick rounded borders of matching wood. On-line painting with anti-yellowing paints; two finishes are available: white and mocha finish oak; controlled-temperature drying in furnace.

Front screen made of 8 mm-thick satin tempered glass anchored to the structure by means of spacers; features a finger slot so that it can be easily moved.

CABINETS:

Cabinet **structure** made of (lightweight) poplar wood particle board panels, hot-laminated with "American oak" fine cut veneer; 1.5 mm-thick rounded borders of matching wood. The side panels (thickness: 40 mm) are fastened to the top surface (thickness 15 mm) by means of a 4 mm-thick aluminium profile.

On-line painting with anti-yellowing paints; two finishes are available: white and mocha finish oak; controlled-temperature drying in furnace.

The cabinet fitments are made of melamine veneer; colour: aluminium

grey.

Adjustable feet mounted on the base in anodised aluminium square plates.

Doors made of (lightweight) poplar wood particleboard, thickness: 20 mm, hot-laminated with "American oak" fine cut veneer; 1.5 mm-thick rounded borders of matching wood. With locks on wooden doors (on request).

Glass doors with anodised aluminium frame and satin tempered glass.

All cabinets can have external drawers and filing drawers constructed as those of the drawer cabinets.

Square anodised aluminium **handles**.

MOBILE CABINETS (with lock)

Mobile cabinet **structure** made of (lightweight) poplar wood particle board panels, hot-laminated with "American oak" fine cut veneer; 1.5 mm-thick rounded borders of matching wood. The side panels (thickness: 40 mm) are fastened to the top surface (thickness 15 mm) by means of a 4 mm-thick aluminium profile.

On-line painting with anti-yellowing paints; two finishes are available: white and mocha finish oak; controlled-temperature drying in furnace.

Back finishing panel.

Adjustable feet mounted on the base in anodised aluminium square plates.

The cabinet fitments are made of melamine veneer; colour: aluminium grey.

Wooden **doors** made of (lightweight) poplar wood particle board panels, hot-laminated with "American oak" fine cut veneer; 1.5 mm-thick rounded borders of matching wood.

Drawers made of silver anodised aluminium, designed to accommodate filing drawers. Stationery tray with a wooden spacer.

"Quadro" steel **guides** sliding by means of precision spheres; automatic closing in the last 60 mm and opening lock. Fully extendable guides when filing drawers are present.

Lock with steel bar and ledge stops for anti-tilt mechanism; chromium-plated double key.

Square anodised aluminium **handles**.

OPEN BOOKCASES

Structure made of mm 35x35 anodised aluminium profiles and "frame"-type wooden side panels hot-laminated with "American oak" fine cut veneer; 1.5 mm-thick rounded borders of matching wood.

The side panels are assembled by means of a 4 mm-thick aluminium profile. On-line painting with anti-yellowing paints; two finishes are available: white and mocha finish oak; controlled-temperature drying in furnace.

Shelving units made of 25 mm-thick (lightweight) poplar wood particle board panels, hot-laminated with "American oak" fine cut veneer; 1.5 mm-thick rounded borders of matching wood. Painted as described above.

Adjustable feet mounted on the base in anodised aluminium square plates.